



## *Remote Sensing (RS)*

Prof. Dr. Ing. Karel Pavelka  
E-mail: [pavelka@fsv.cvut.cz](mailto:pavelka@fsv.cvut.cz)



**Motto:**  
Remote sensing of the Earth... but not only for the Earth, but for other objects in the Solar system. There is currently no other way to explore the Solar system.



2020: Mars Perseverance rover

# Remote sensing of the Earth

## Geoinformatics (+ GIS)

basic sources of primary information about the territory:

- **geodetic methods** accuracy in the order of **mm - cm**
- **photogrammetry** accuracy in **cm - dm**
- **RS** accuracy in the order of **m - km**
- **photo-interpretation**

# Defining RS

- **RS** is a method that allows the acquisition and processing of data measured in a non-contact manner. The carrier of the information is electromagnetic radiation .
- **Principle**: each object or state characteristically affects the surrounding force fields (in this case, the electromagnetic radiation)



# Explanation of the definition

- Measurement of electromagnetic radiation = data collection
- Data processing - interpretation and analysis of measurements to obtain new information
- Most of the data is image data
- The data contains 2 types of information:
  - *spatial information* (**photogrammetry**)
  - *thematic information* (**RS**)

# Naming in different languages

- Dálkový průzkum Země (CZ)
- Télédétection (F)
- Die Fernerkundung der Erde (D)
- (Earth) Remote Sensing (EN)
- Дистанционное зондирование (RUS)
- Teledetección (E)
- Telerilevamento (I)

# Diagram of the RS

- A, D radiation source
- B incident radiation
- C measured area
- D receiver
- reflected/emitting radiation
- E record transfer to the receiving station
- F pre-processing
- G RS data processing

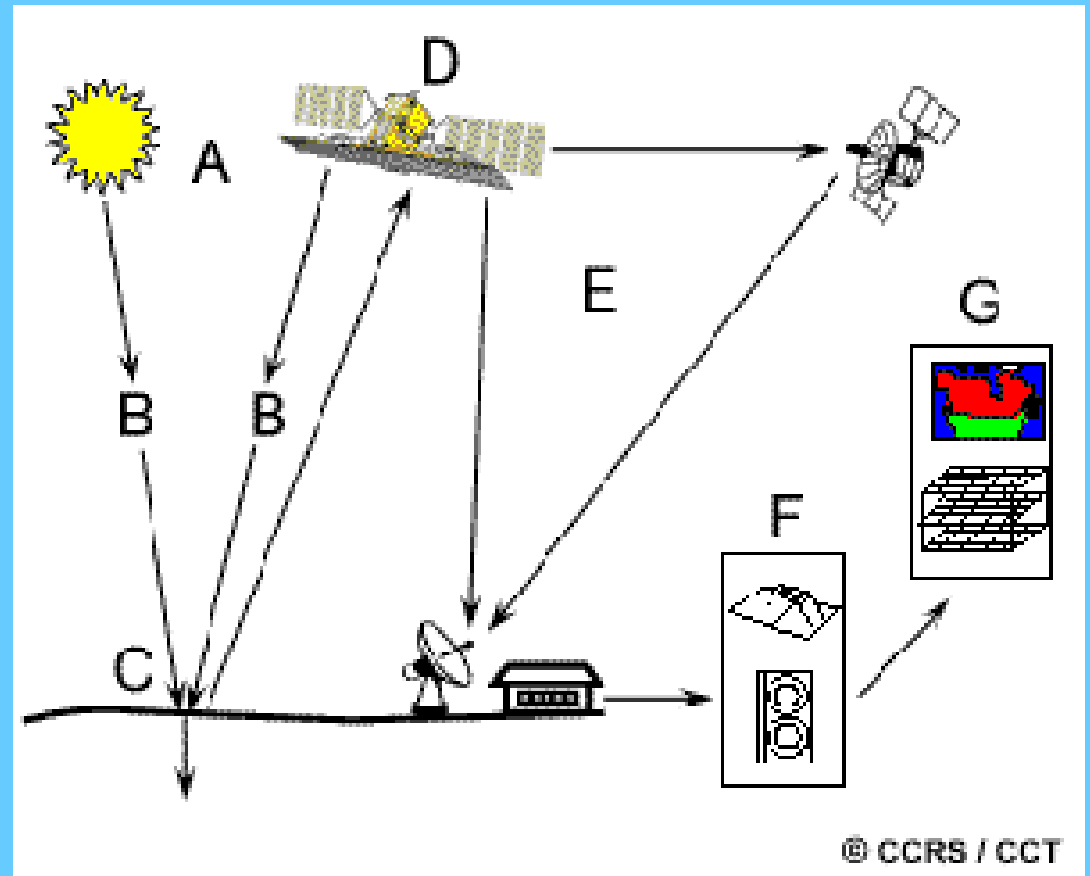

# History of RS

- *Remote sensing* (a term first used in the mid-50s by Ms E.Pruitt)
- The term RS was introduced in the Czech Republic in the 1970s (Šíma)
- Information on electromagnetic radiation since the 17th century
- Photographs - image data from the 19th century
- Development since World War II, use especially since the 1970s

# Electromagnetic radiation

- 1666 - Isaac Newton uses an optical prism to split white light into its individual spectral colours

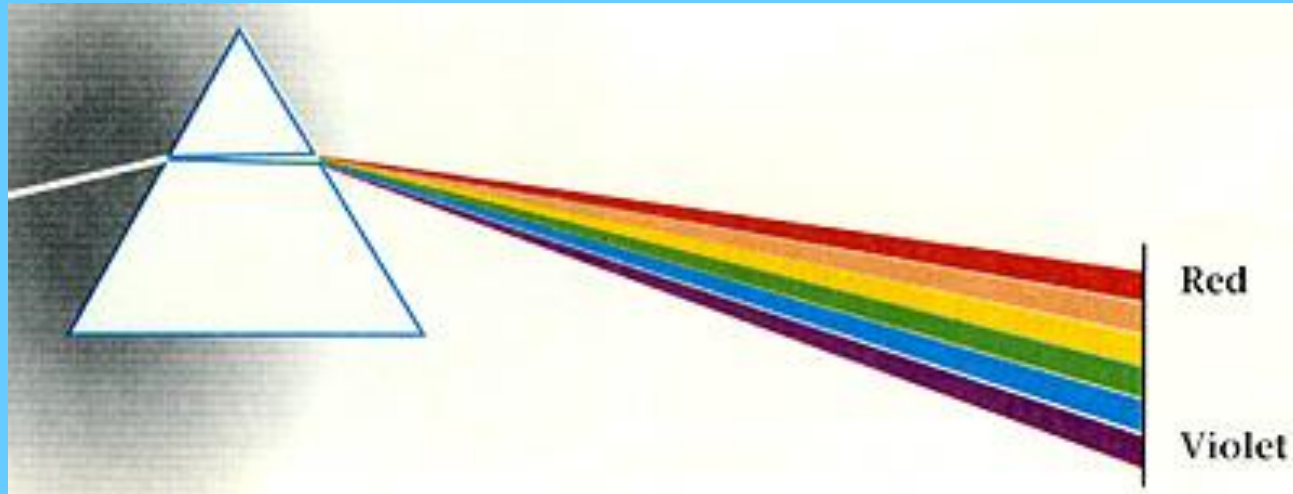

- 1800 -discovery of infrared radiation (Sir W. Herschel )
- 1847 - A.H.L. Fizeau and B.L. Foucault prove that infrared radiation has similar properties to visible radiation
- 1873 - Physical theory of electromagnetic radiation, equations (J.C. Maxwell )

# Photo

- **1777 invention of the light-sensitive compound. AgCl (C.H.Scheele)**
- **- Fundamentals of Photography Technology - W.H.Fox Talbot**
- **1839 - first photographs by N. Niepce, L.J.M. Daguerre**
- **- the title of the photo comes from J.Herschel**
- **1858 - Tournacone called Nadar) (F) balloon photo**
- **1860 - J.W.Black - photograph of Boston from a balloon**
- **G.Eastman, 1884 (paper film) and its introduction in 1889 (celluloid film, first roll film camera)**
- **1903 - J. Neubronne - patent for pigeon photography**
- **In 1935, the first Kodakchrome colour film was released**

# Pioneering Photography



•photography with the help of a pigeon

•photos of Boston from a balloon



# History of aerial photography

- **1909** - W. Wright - first photograph from an airplane
- **1906 - 1908** - first balloon photographs in Bohemia - J. Plischke - area near today's Exhibition Grounds in Prague
- **World War I** - development of aerial photography
- **period before World War II** - development of aerial photogrammetry, part of the Czech Republic on aerial photographs
- **World War II** - development of new technologies
- **After World War II** - development of aerial and satellite (after 1957) methods of photography

# Other types of data

The period after the end of World War II:

- *the first steps of rocket technology*
- *the invention of radar*
- *use of infrared radiation* - for vegetation health (R.Colwell) - **Camouflage detection film**

# Space Imaging

- **1946 - 1950** - experiments with German V-2 rockets
- **1957** The first artificial Earth satellite (Sputnik 1)
- **1958** - The first image of the Earth's surface taken from a satellite - **Explorer 1**



# Space technology development

- **1960** - launch of TIROS satellite - 1 = **beginning of satellite DPZ**
- **1960s** - manned spaceflight, lots of data taken from spacecraft - Apollo, Gemini, Mercury, Soyuz, Vostok
  - geostationary satellites are being formed from originally communication satellites
  - satellite stations (Saljut, MIR, Skylab, ISS)
  - satellite specialisation

# Specialised RS satellites

- **1972** - ERTS (secondarily renamed Landsat) = the **real beginning of RS** - commercial satellites
- **1978 Seasat** first radar satellite
- **1984 - SPOT** - European satellite
- **1980s** - development of synthetic aperture radar (SAR), ERS (European Radar Satellite), Radarsat
- **1990s** - the emergence of digital photogrammetry
- **1999** meter resolution data, private satellite
  
- **RS data = GIS input data**

# Physical basics of RS

- Important to understand the issues;
- gives an explanation of why this method is possible, its limitations, the individual effects of the phenomena that need to be known and understood in order for the user to use RS

# Electromagnetic radiation

- The basis is the definition of the actual el.mag.radiation - light
- The quantum description of electromagnetic radiation is based on the assumption that radiation consists of particles - photons. The particle properties of radiation are more pronounced at wavelengths comparable to the size of elementary particles.
- A photon is a form of energy - a quantum  
In the wave description according to Maxwell's theory, electromagnetic radiation is a transverse wave of the electromagnetic field, where the magnitude of the electric field intensity and the magnitude of the magnetic field intensity change periodically.
- radiation can be emitted, absorbed or reflected
- radiation has a dual character (wave and quantum description of radiation)



# Sources of radiation

Electromagnetic radiation is produced when the momentum of particles changes. According to its origin it is divided into:

**radiation of thermal and non-thermal origin.**

- Radiation of non-thermal origin arises e.g. when an electron moving at a speed close to the speed of light in a vacuum penetrates the Earth's atmosphere (Cherenkov radiation) or e.g. as synchrotron radiation of a relativistic electron in a magnetic field.
- Continuous radiation of thermal origin is dominant for the RS region. This radiation is emitted by any object with a temperature greater than 0 K. At this temperature all motion ceases. The ideal case is the radiation of an absolutely black body, which can absorb and emit all radiation without any residue.
- **Rotational motion of atoms** in molecules (IR and MW)
- **Oscillatory motion of atoms** around their bonds - the frequency depends on the type of atoms and bond and these frequencies are characteristic for each molecule (near and mid IR)
- A group of several close frequencies form a band, the spectrum of molecular radiation = **band spectrum**
- **Transitions of electrons between paths** in atoms - the paths are characteristic for each atom, therefore the emitted radiation is typical for the atom - the formation of **a line spectrum** - in this way ultraviolet (UV), visible (V), infrared (IR) radiation is produced
- **In nature, a mostly continuous spectrum** - multiple processes leading to radiation

# Electromagnetic radiation

- Electromagnetic radiation = information carrier in RS
  - The wave has a shape described by a sine function

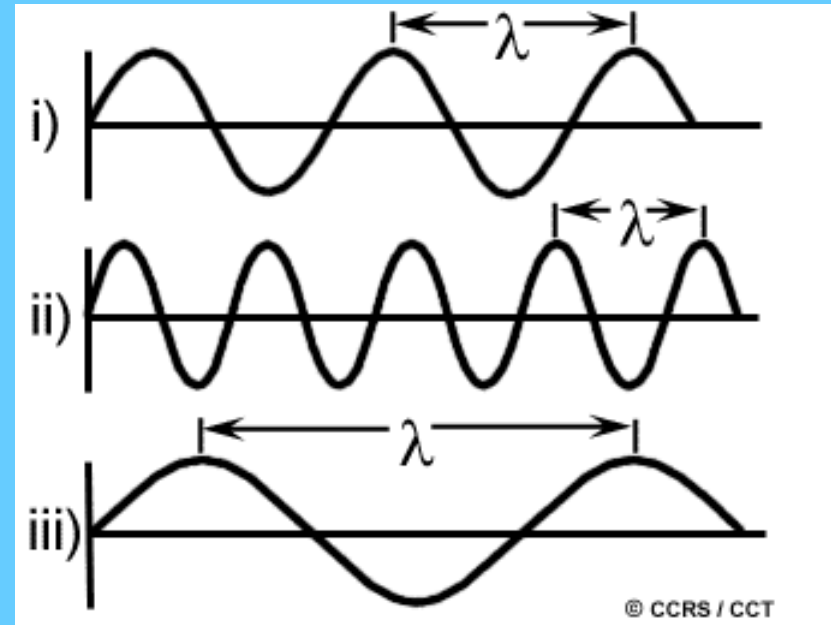
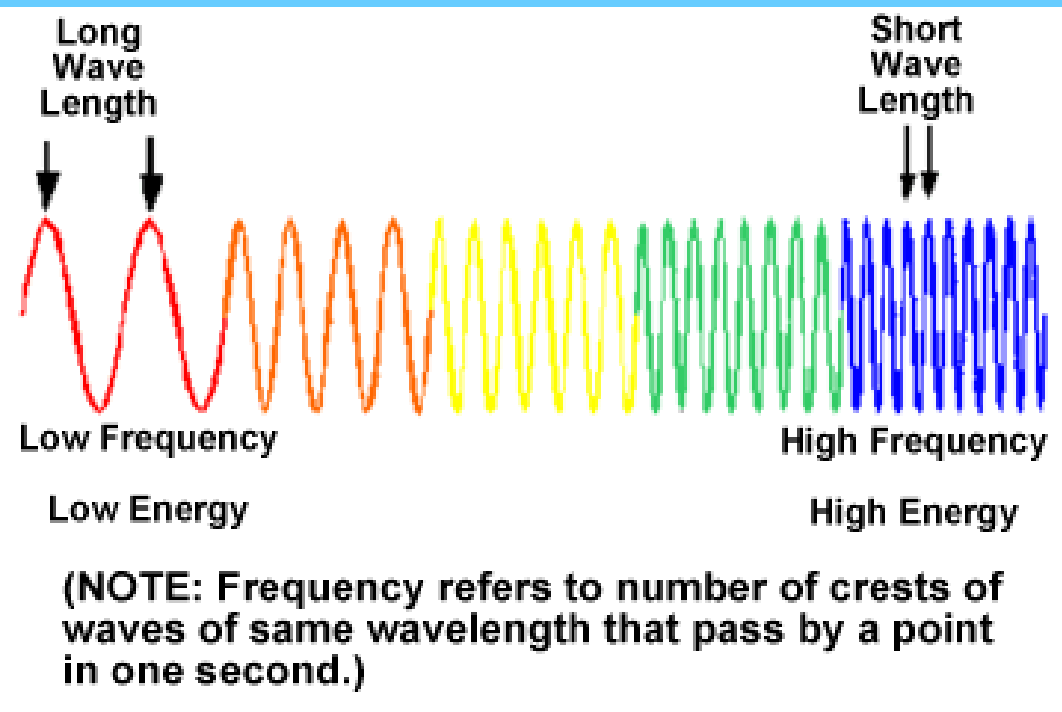

# Electromagnetic radiation

- A **photon** in the form of an el-mag wave has 2 components:
  - **Electric with** intensity vector  $E$  of the electric field
  - **Magnetic with** intensity vector  $M$  magn.field

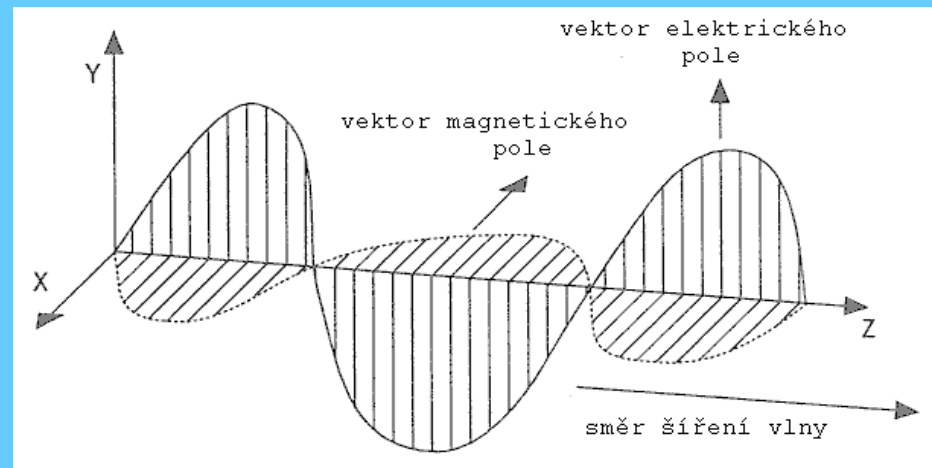
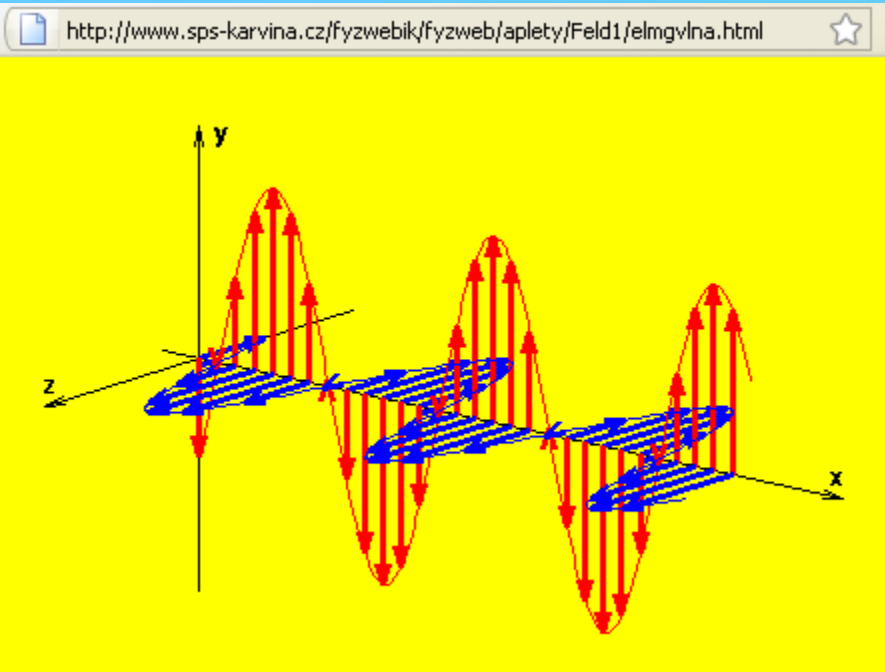

# Electromagnetic radiation

## Electromagnetic spectrum

- The distribution of photons with different energies for different frequencies is shown

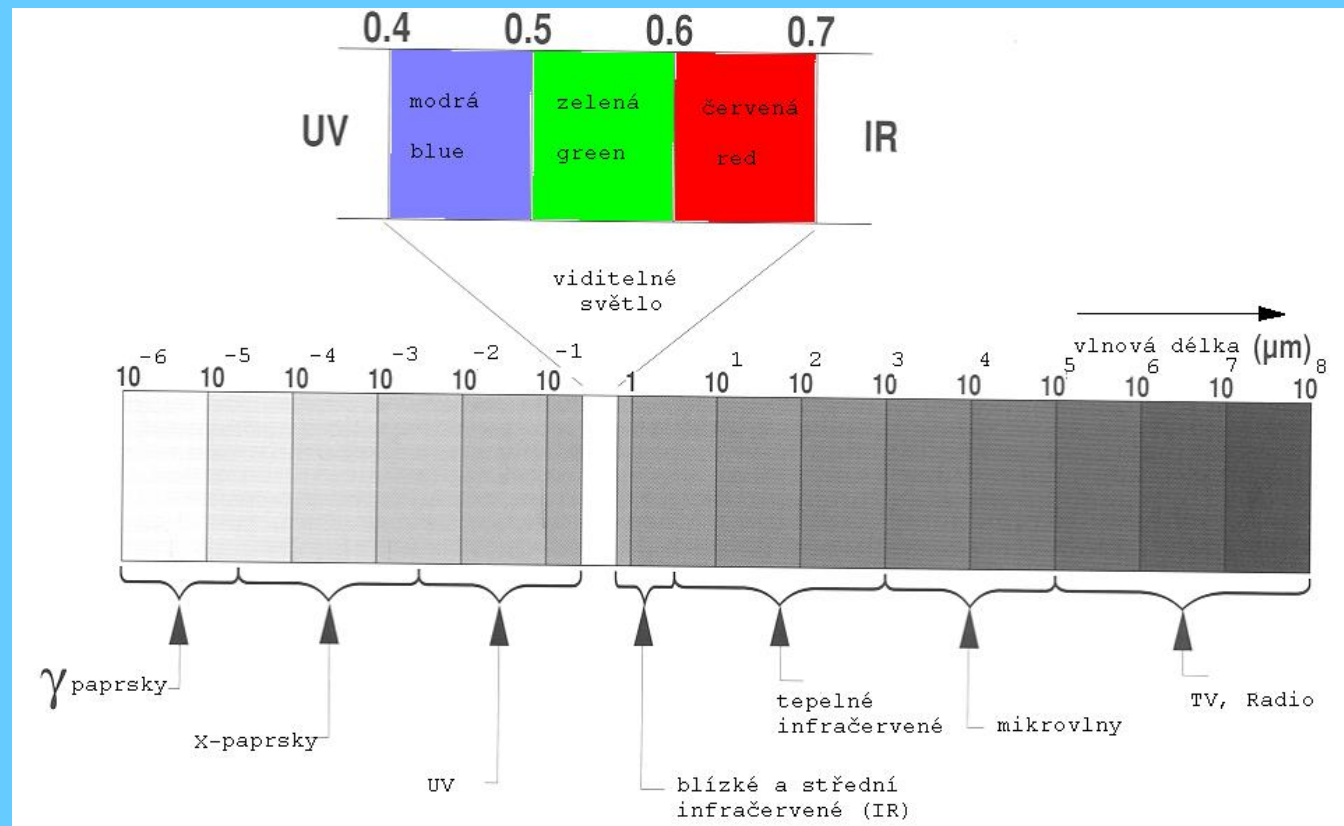

# Electromagnetic radiation

## continuous spectrum



# Types of microwave radiation

## Band Frequency (GHz) Wave range (cm)

- Ka 40 - 26.5 0.8 - 1.1
- K 26,5 - 18 1,1 - 1,7
- Ku 18 - 12.5 1.7 - 2.4
- X 12,5 - 8 2,4 - 3,8
- C 8 - 4 3,8 - 7,5
- S 4 - 2 7,5 - 15,0
- L 2 - 1 15,0 - 30,0
- P 1 - 0,3 30,0 - 100,0

# Types of microwave radiation

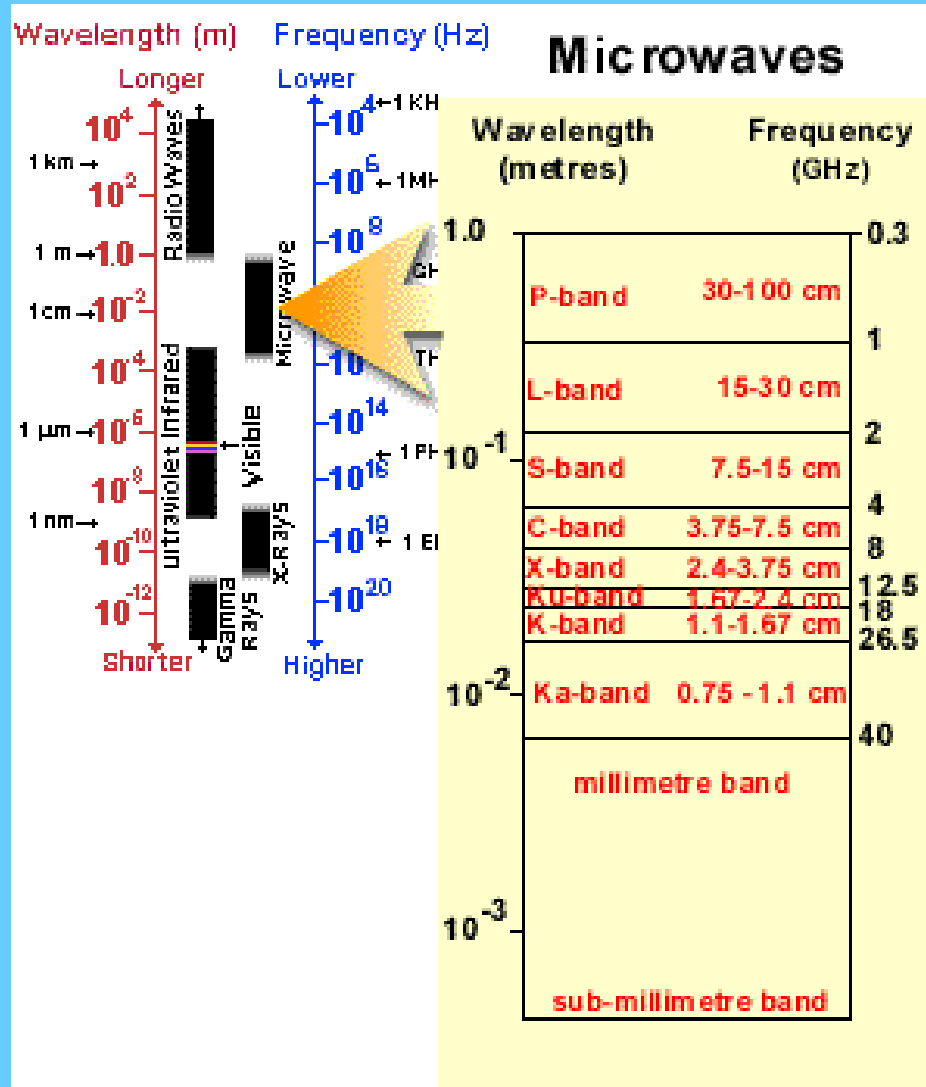



# Description of electromagnetic radiation

# Radiometric quantities

- $Q$  - radiant energy (J)
- $\Phi$  - radiant flux (W)
- $M$  - radiant exitance ( $\text{W}/\text{m}^2$ )
- $E$  - irradiance (Flux density) ( $\text{W}/\text{m}^2$ )
- $I$  - radiant intensity ( $\text{W}/\text{sr}$ )
- $L$  - radiance ( $\text{W}/(\text{m}^2 \cdot \text{sr})$ )

<https://en.wikipedia.org/wiki/Radiometry>

# Electromagnetic radiation

- **wavelength** =  $c.T$ ,
- is the distance between the 2 vertices of the sinusoids
  - where  $c$  is the speed of light (about  $3 \cdot 10^8$  km/s)
  - $T$  is the time of one period
  - $f$  is the frequency, which is the total number of peaks passing through 1 point in 1 second

$$f = 1/T$$

$$\underline{\lambda = c/f}$$

# Electromagnetic radiation

- The energy of a single photon is expressed by the Planck equation

$$E = h.f,$$

where  $h$  is **Planck's constant**  $6.6260 \times 10^{-34}$  J/s

# Radiation energy

**Planck's equation** - wavelength dependence of radiation intensity as spectral intensity of radiation

$$B_{\nu} = \frac{2h\nu^3}{c^2} \cdot \frac{1}{\exp(h\nu/kT) - 1}$$

where  $k = 1.4 \cdot 10^{-23} \text{ JK}^{-1}$  is the Boltzmann constant,  $T$  is the radiant temperature,  $h = 6.62 \cdot 10^{-34} \text{ J.s}$  is the Planck constant

# Radiation energy

- Blackbody spectral intensity curves as a function of temperature

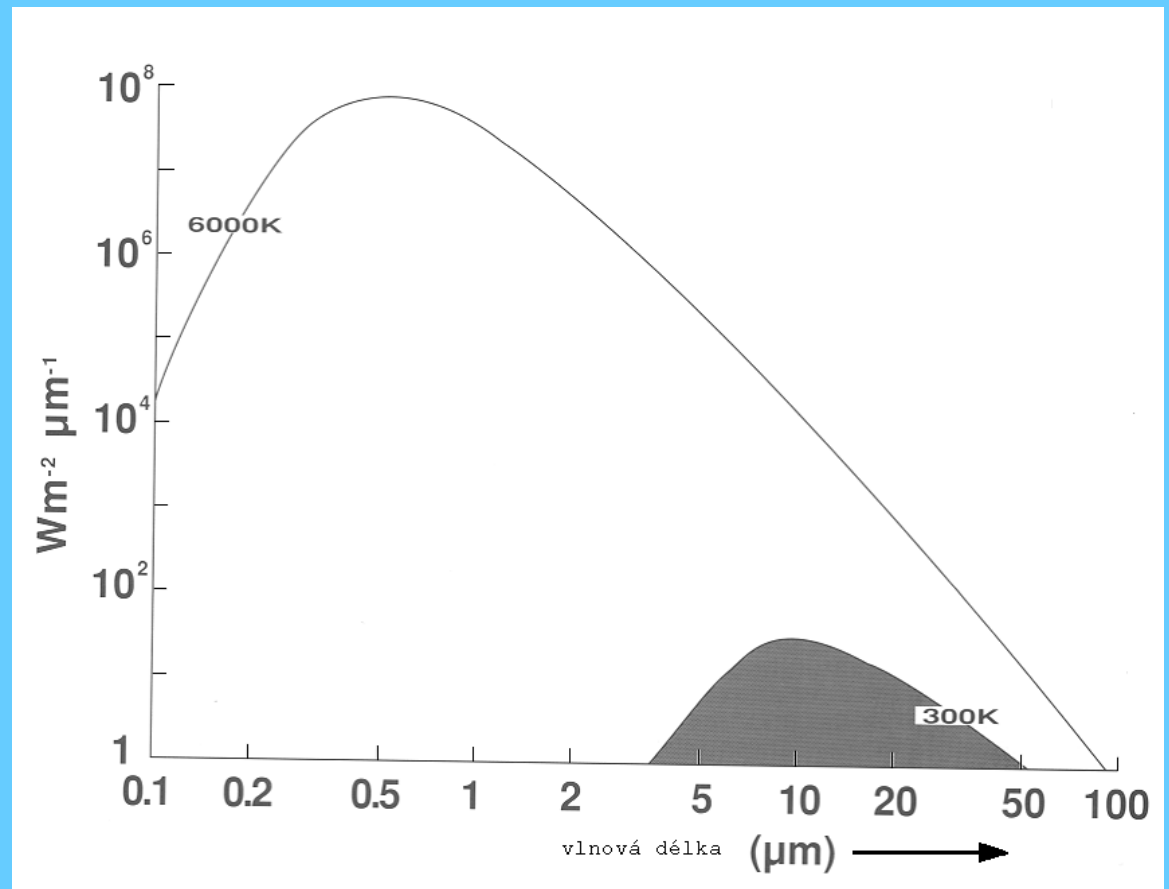
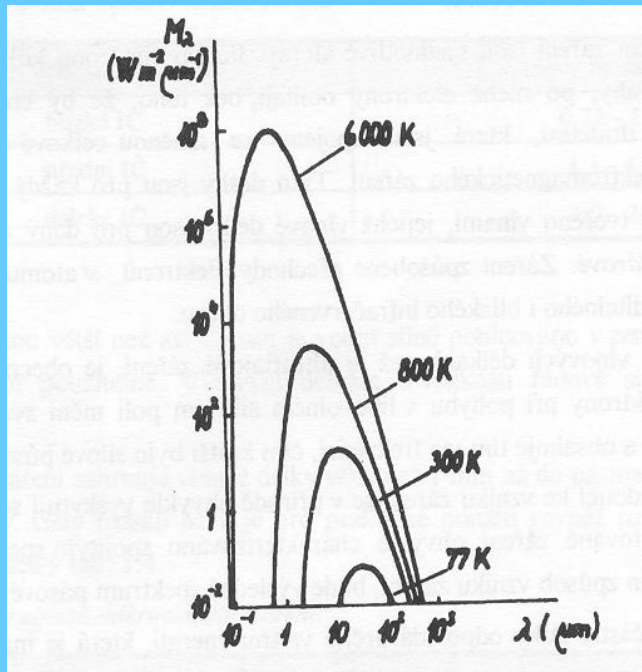

# Planck's equation - and the actual course - of solar absorption through the Earth's atmosphere

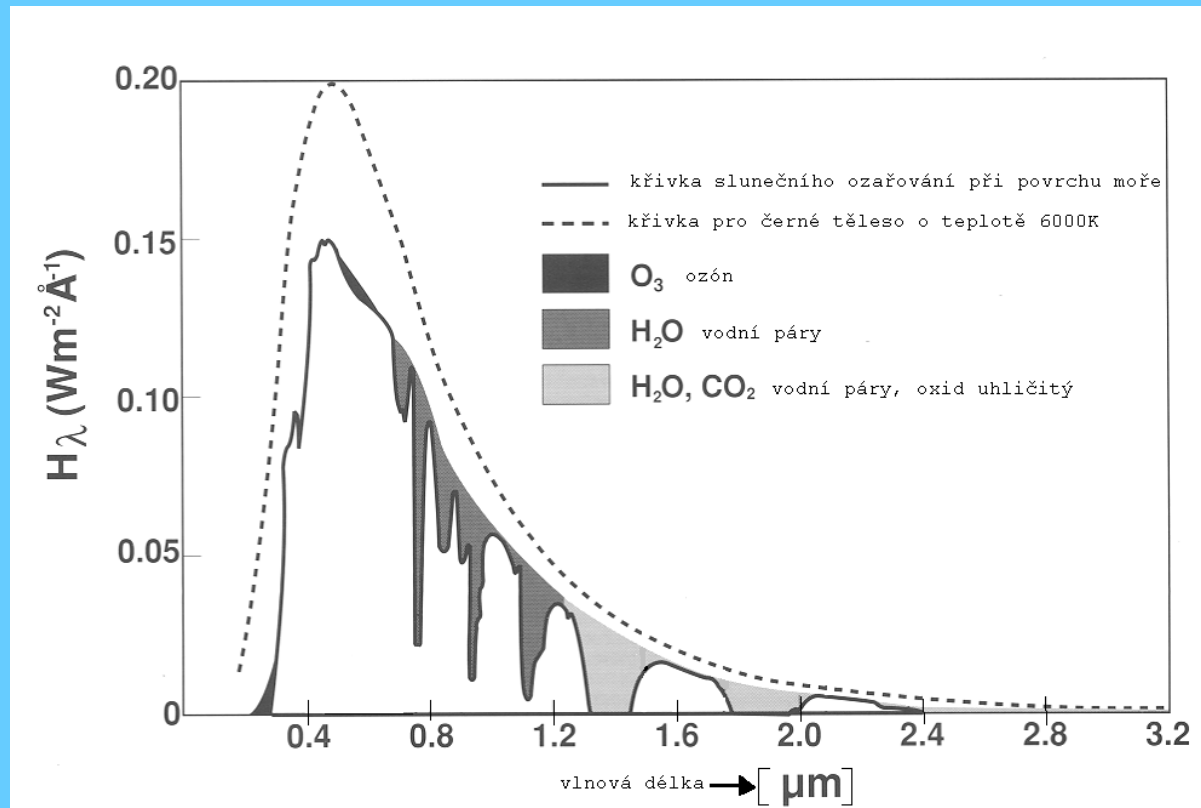



# Radiation energy

- Max. value for the wavelength expressed by **Wien's displacement law**

$$\lambda_{MAX} = \frac{2898}{T} \left[ \mu m \right]$$

The wavelength for the **maximum intensity of radiation** shifts to shorter wavelengths for increasing body temperature

The Sun's photosphere has a temperature of 6000K and its maximum emission lies at a wavelength of 0.48m (yellow light; the Earth (300K ) emits a maximum in the thermal infrared - 12m ).

# Radiation energy

- **Stefan-Boltzmann law** - the relationship between the total intensity of radiation produced by a black body (all kinetic energy is converted to radiant energy) and its temperature

$$M_{\text{Black}} = \sigma T^4$$

Where  $\sigma$  is the constant  $5.6693 \cdot 10^{-8} \text{ W} \cdot \text{m}^{-2} \cdot \text{K}^{-4}$

**Every body with temperature higher than  $T=0$**  is a source of electromagnetic radiation

# Lambert's Law

- Surfaces radiating in accordance with Lambert's law (=cosine law) - **lambertian** or **perfectly diffuse** surfaces - plaster, filter paper
- These surfaces are also referred to as **point** sources, i.e. sources whose distance is at least 20 times greater than its lateral dimension
- For **area sources** - the radiometric quantities must be determined by integration over the solid angle from which the radiation strikes the site under investigation

# Photometric quantities

In addition to radiometric quantities, **photometric quantities are also used** to measure visible radiation

- $Q_v$  Luminous energy (lm.s)      lm=lumen
  - $\Phi_v$  - luminous flux (lm)
  - $M_v$  - Luminous exitance (lm/m<sup>2</sup> )
  - $E_v$  - Illuminance (lux=lm/m<sup>2</sup> )
  - $I_v$  - Luminous intensity (cd=lm/sr)      cd = candela
  - $L_v$  - Luminance (nit = cd/m<sup>2</sup> )
- 
- Lumens are a measure of light output. Watts are a measure of electrical power.
  - An ideal source radiating a power of one watt of light in the color for which the eye is most efficient (a wavelength of 555 nm, in the green region of the optical spectrum) has luminous flux of 683 lumens.
  - For normal use, the ratio of lumens to watts varies with the type of light bulb and efficacy. For example 1 W cca = 12-200 lm (!)

# Photometric quantities

- They describe the perception of the human eye - a historically older approach to describing light
- The magnitude of luminous efficiency is different for different wavelengths, so it is a **spectral quantity**
- **maximum luminous efficacy** for  $\lambda = 0.555\text{m}$
- Relationships between radiometric and photometric quantities for  $\lambda = 0.555\text{m}$

1 Watt = 683 lm (lumens)

- The relationships between photometric quantities are similar to those between radiometric quantities, i.e.

$$E_v = \pi \cdot L_v$$

# Radiation sources and types of RS

- **Passive RS** - natural source of electromagnetic radiation - Sun, Earth

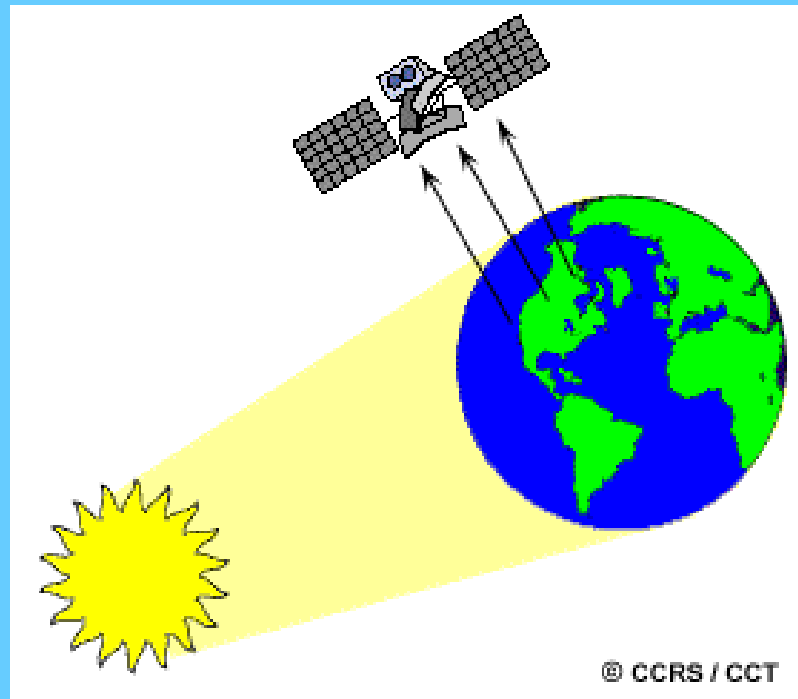

# Radiation sources and types of RS

- **Active RS** - artificial source of electromagnetic radiation

- **Radar, laser** - active sources in RS - coherent radiation

$\lambda$  in the cm wave range  
(1cm - 1m ) = radar

$\lambda$  in the range of V and IR radiation - lidar (laser)

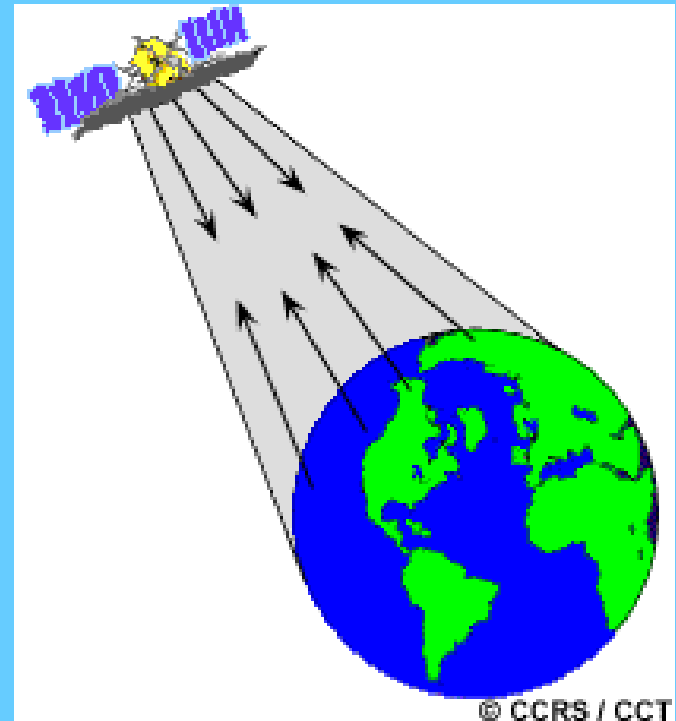

# Natural sources of radiation - the Sun

The Sun's thermal radiation is similar to that of a black body with a surface temperature of around 6000 K

– Difference in the UV part and partly in the visible part - caused by absorption of the lower part of the atmosphere

For the UV part - similar to a black body with a temperature of 4500 K

For the IR part - similar to a black body with a temperature of 5000 K



# Interaction of radiation with the environment

$$\alpha + \tau + \rho = 1$$

For these relationships, it describes the absorbance, transmittance and reflectance

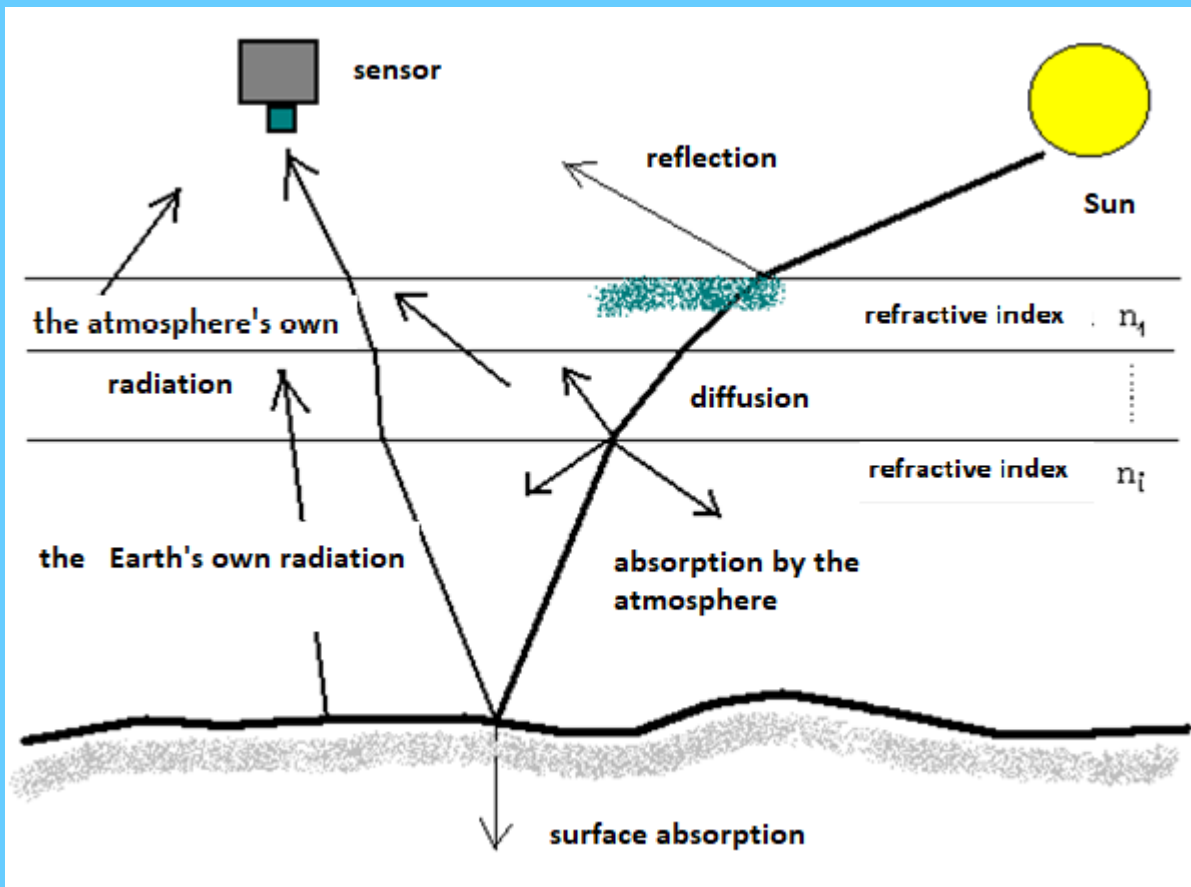

# Interaction of radiation with the environment

- **Throughput**  
(transmission)
- Reflection
- **Absorption**  
(absorption)
- **Scatter**  
(scattering)

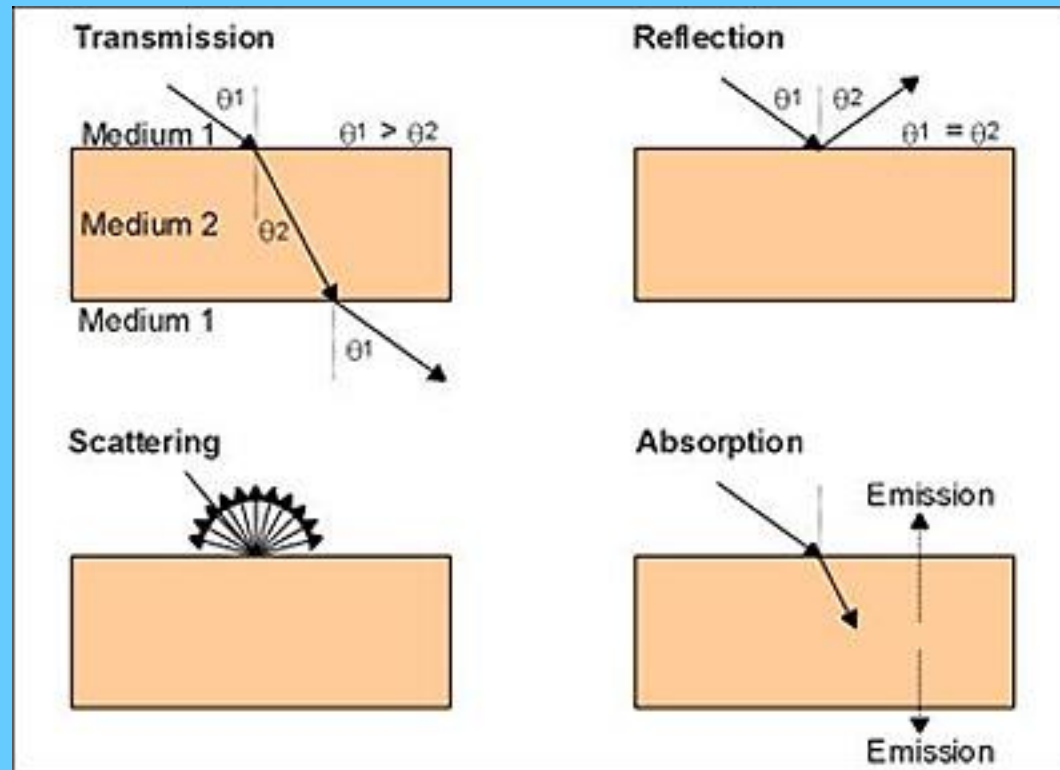

# Atmosphere

Atmosphere - the environment through which incident and reflected radiation passes

The atmosphere is a material environment - radiation is :

- reflected/dispersed
- absorbed
- Issued by

The spectral intensity of the radiation of objects measured on the carrier is different from that measured on Earth in the vicinity of these objects

# Atmosphere

The magnitude of the effect of the atmosphere on the passing el-mag radiation depends on :

- on the length of passage through the atmosphere
- on the amount of inhomogeneities in the atmosphere

This effect must be taken into account for the monitoring of the Earth's surface

However, the object of observation may be the atmosphere itself, then the data must be corrected for the effect of the Earth's reflectivity

# Atmosphere

Evaluation of the difference between the measured radiometric value on the ground and on the carrier  
- describes the transmission equations

The transmission equation describes the propagation of radiant energy in the direction of the zenith angle

Atmospheric influence - for both airborne and satellite launchers

# Composition of the atmosphere

Pollutants = aerosols - natural and man-made

decisive influence - particle size

Concentration

aerosol morphology

Particle size ( $10^{-3}$  m -  $10^4$  m) and

concentration are related

# Interaction of radiation with the atmosphere

The atmosphere rotates with the Earth, is in constant motion and changing

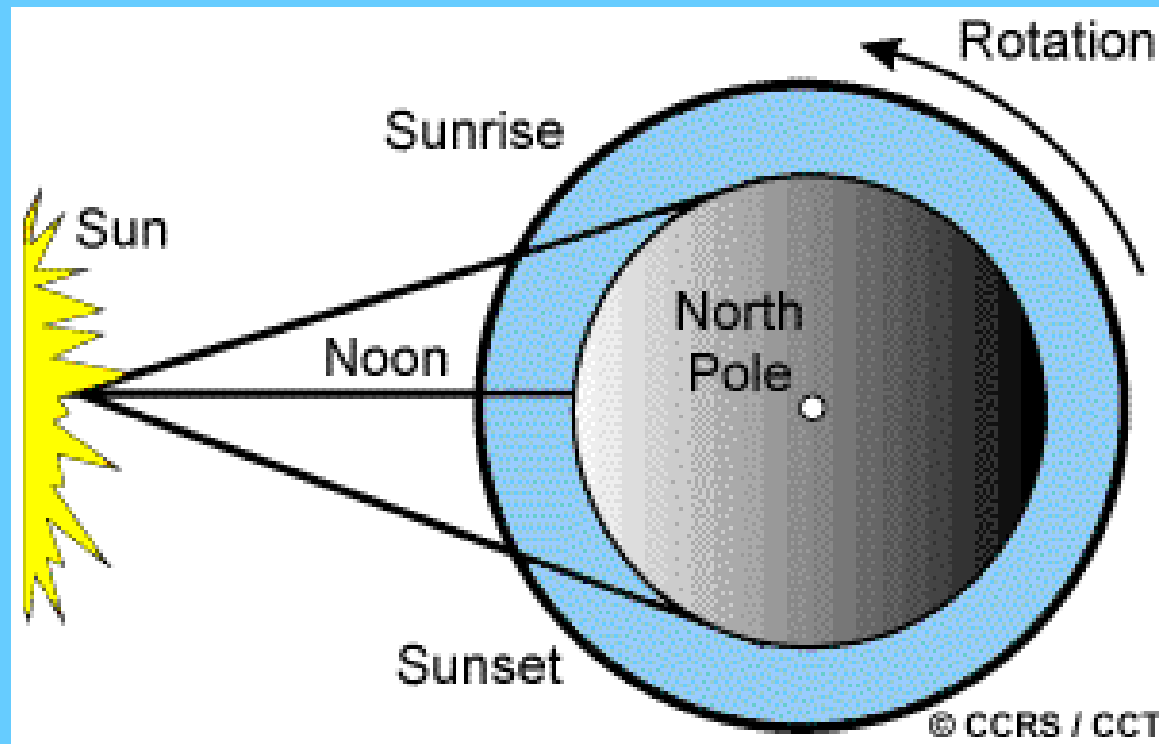

# Interaction of radiation with the atmosphere - absorption

## Absorption belts

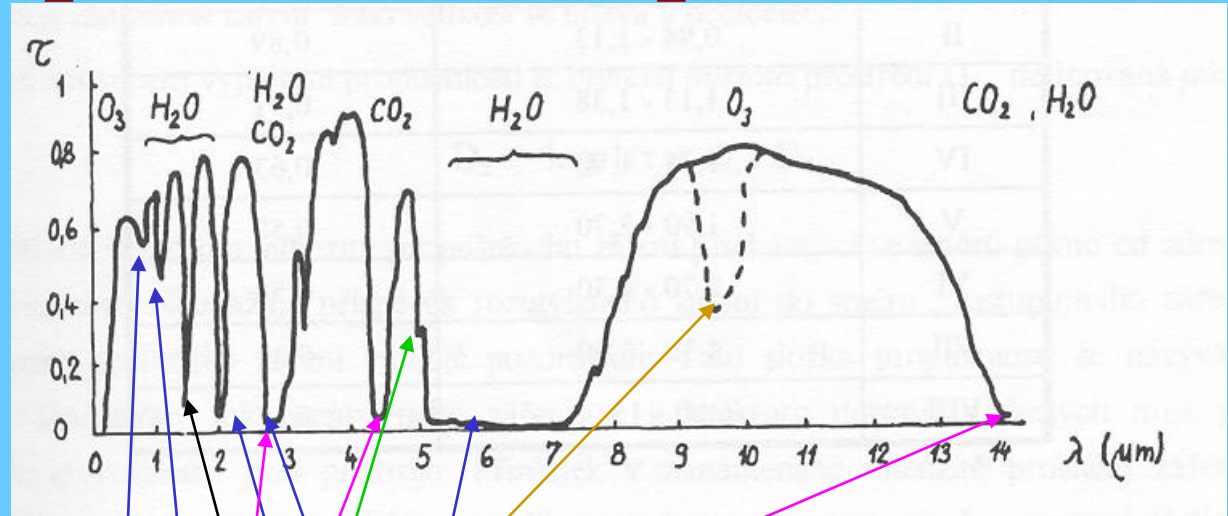

molekula	střed absorpčního pásu ( $\mu\text{m}$ )
$\text{H}_2\text{O}$	0,9; 1,1; 1,4; 1,9; 2,7; 6,3
$\text{CO}_2$	2,7; 4,3; 15
$\text{O}_3$	9,6
$\text{CO}$	4,8
$\text{CH}_4$	3,3; 7,8
$\text{N}_2\text{O}$	4,6; 7,8



# Interaction of radiation with the atmosphere - absorption

## Absorption belts -

Water - large number of bands - IR and MW bands - the net rotational spectrum at the ground vibrational state of a water molecule is about 50 m (but is from 10 m to 1 cm)

CO<sub>2</sub> - thick belt over 15 m

O<sub>3</sub> - highest concentration at 25 km (stratosphere) - significant UV absorption and then a band of 9.6 m and MW around 1 mm

Next - nitrogen, oxygen, methane

# Interaction of radiation with the atmosphere - absorption

DPZ uses the bands between the absorption bands = **atmospheric windows** - the table is valid for a water volume concentration of  $10^{-4}$  %

Okno	Vlnový rozsah ( $\mu\text{m}$ )	Propustnost $\tau$
I	0,72 - 0,94	0,91
II	0,94 - 1,13	0,89
III	1,13 - 1,38	0,71
IV	1,38 - 1,90	0,63
V	1,90 - 2,70	0,58
VI	2,70 - 4,30	0,58
VII	4,30 - 6,00	0,31
VIII	6,00 - 15,00	0,47

# The shining properties of landscape objects

# Shining properties of landscape objects

- The intensity of the reflected/emitted radiation depends on the type of substance, its physical state and the state of the surroundings
  - Reflectivity/emissivity is a characteristic feature of a substance
  - Knowledge of these reflectances - allows to determine which substance is involved = principle of RS

# Shining properties of landscape objects

- The individual substances are characterised:
  - **Species parameters** = indicate membership of a class (species, i.e. woodland, maize pools, etc.)
  - **State parameters** = indicate the state of the measured substance (moisture, admixture, temperature, ...)

# The shining properties of landscape objects

- The radiative properties are described by the **spectral characteristic** = the dependence of reflectance/emissivity on wavelength
- Properties are measured in laboratories and in the field
- From the knowledge of the spectral characteristics, the most suitable spectral band for the measurement can be determined
- An infinite number of spectral characteristics for different species and their states

# Shining properties of landscape objects

- 4 basic spectral characteristics
- 1-water
- 2-vegetation
- 3-dry soil
- 4-moist soil

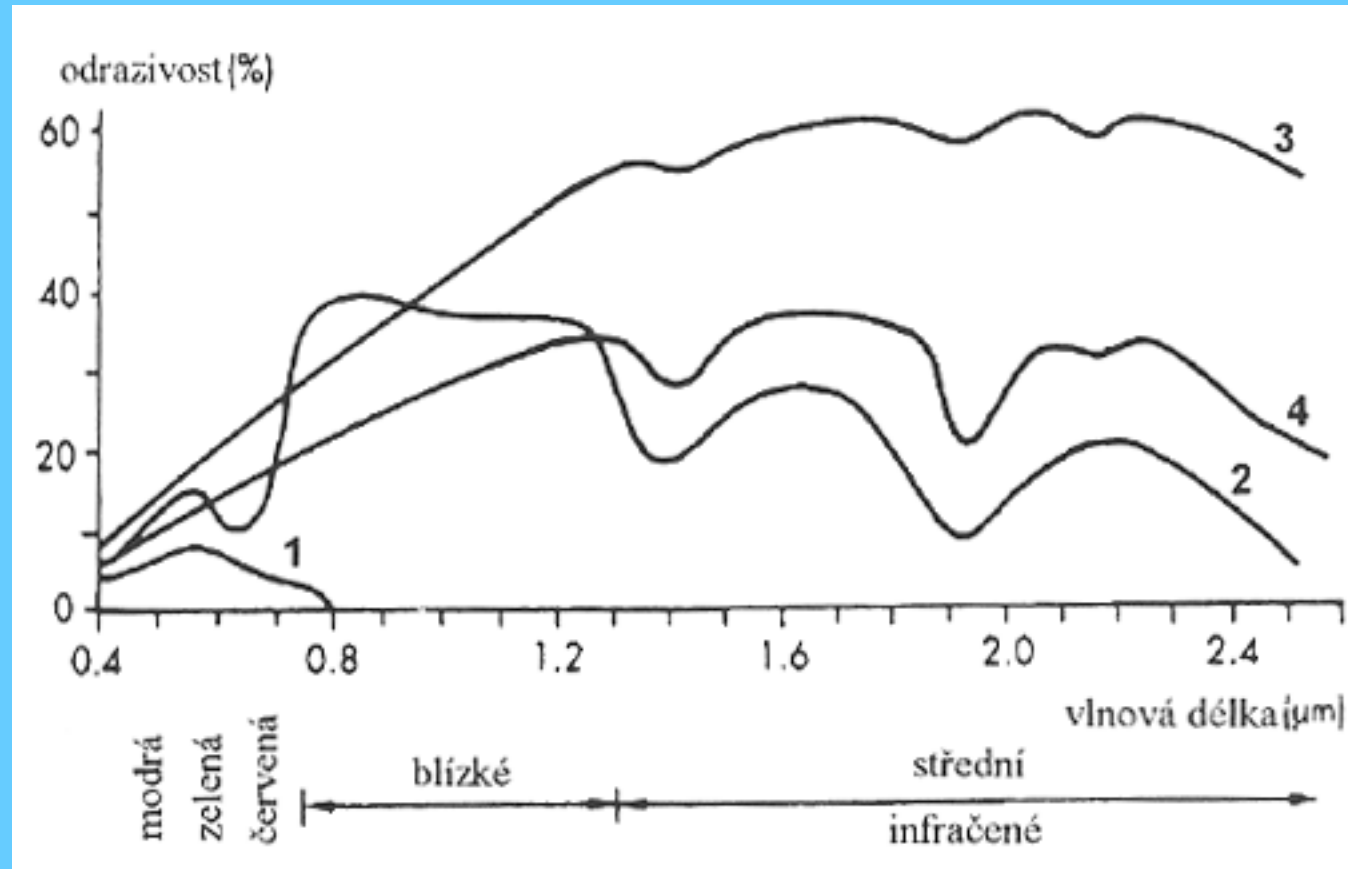

# The shining properties of landscape objects

- Spectral characteristics - also depend on the season - vegetation is typical - a characteristic feature for recognition
- Measurement of vegetated areas - resolution meters - tens to hundreds of meters - not one plant is measured - but the whole community - in this environment there are **multiple reflections** and **reflection from different parts of the plant**



# Shining properties of landscape objects - vegetation

- 3 factors of spectral reflectance of vegetation in VIS and IR radiation

I the pigmentation area  
absorption  $0,4 - 0,6\mu\text{m}$

II area of high  
reflectivity or  
cellular structures

III. water absorption area -  $1.3 - 3 \mu\text{m}$

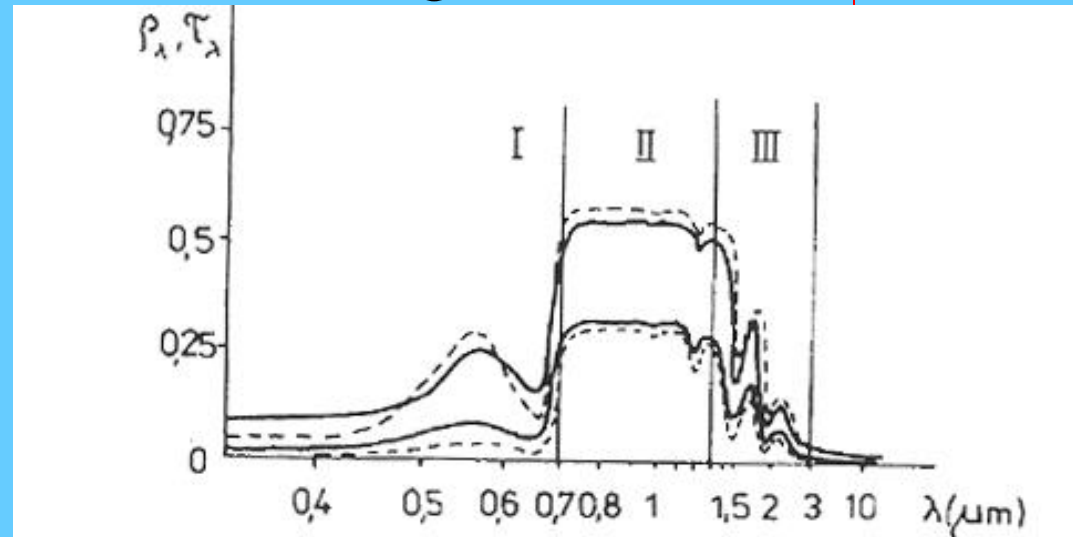

Spectral reflectance of vegetation (VIS - IR)

# Shining features of landscape objects - vegetation

- In the VIS region, the spectral characteristic is influenced by pigmentation:
  - **Chlorophyll** - absorbed in blue ( $0.45 \mu\text{m}$ )  
– and red band ( $0.65 \mu\text{m}$ )
    - in the green band
      - Reflected radiation low intensity - significant absorption
  - **Carotene, xanthophyll** - yellow dye - absorption band in blue

# Shining properties of landscape objects - vegetation

## Vegetation indices:

- They quantify the increase in reflectance from the red absorption band ( $R_R$ ) to the high reflectance region in the IR ( $R_{IR}$ )
- $VI = R_{IR} - R_R$  - differential VI
- Normalized VI = NDVI:
- $NDVI = (R_{IR} - R_R) / (R_{IR} + R_R)$

# Radiant properties of landscape objects - water

- In the IR, water does not reflect radiation- it is dark in the images

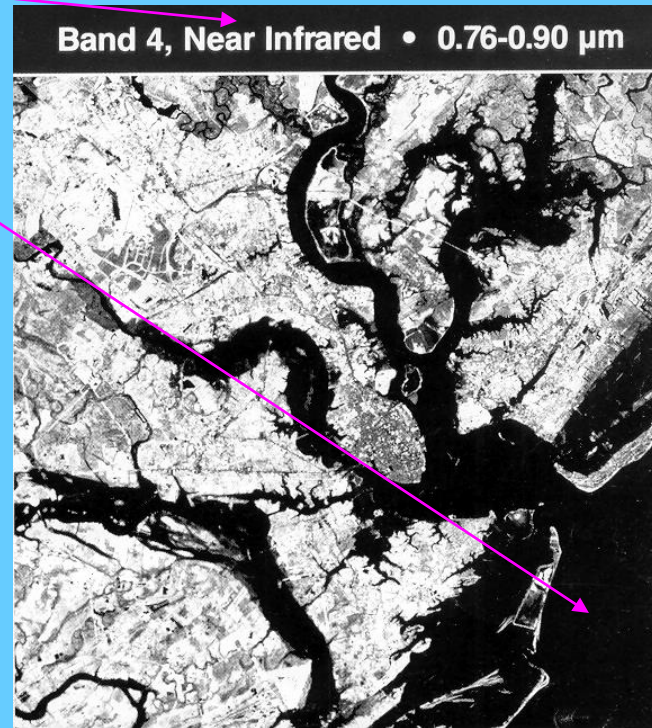



# Radiant properties of landscape objects - water

- Determination of oil pollution on radar image

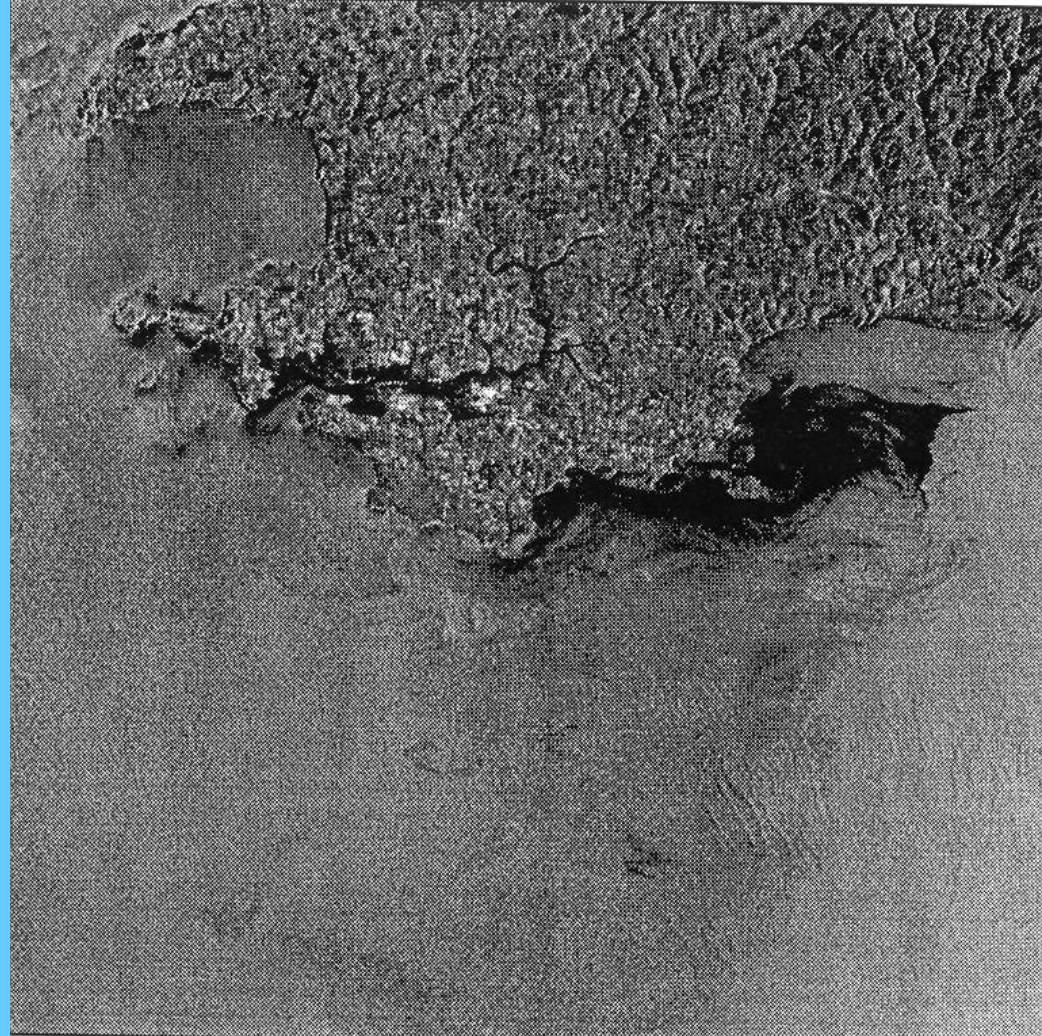

# Radiant properties of landscape objects - surfaces without vegetation - minerals and rocks

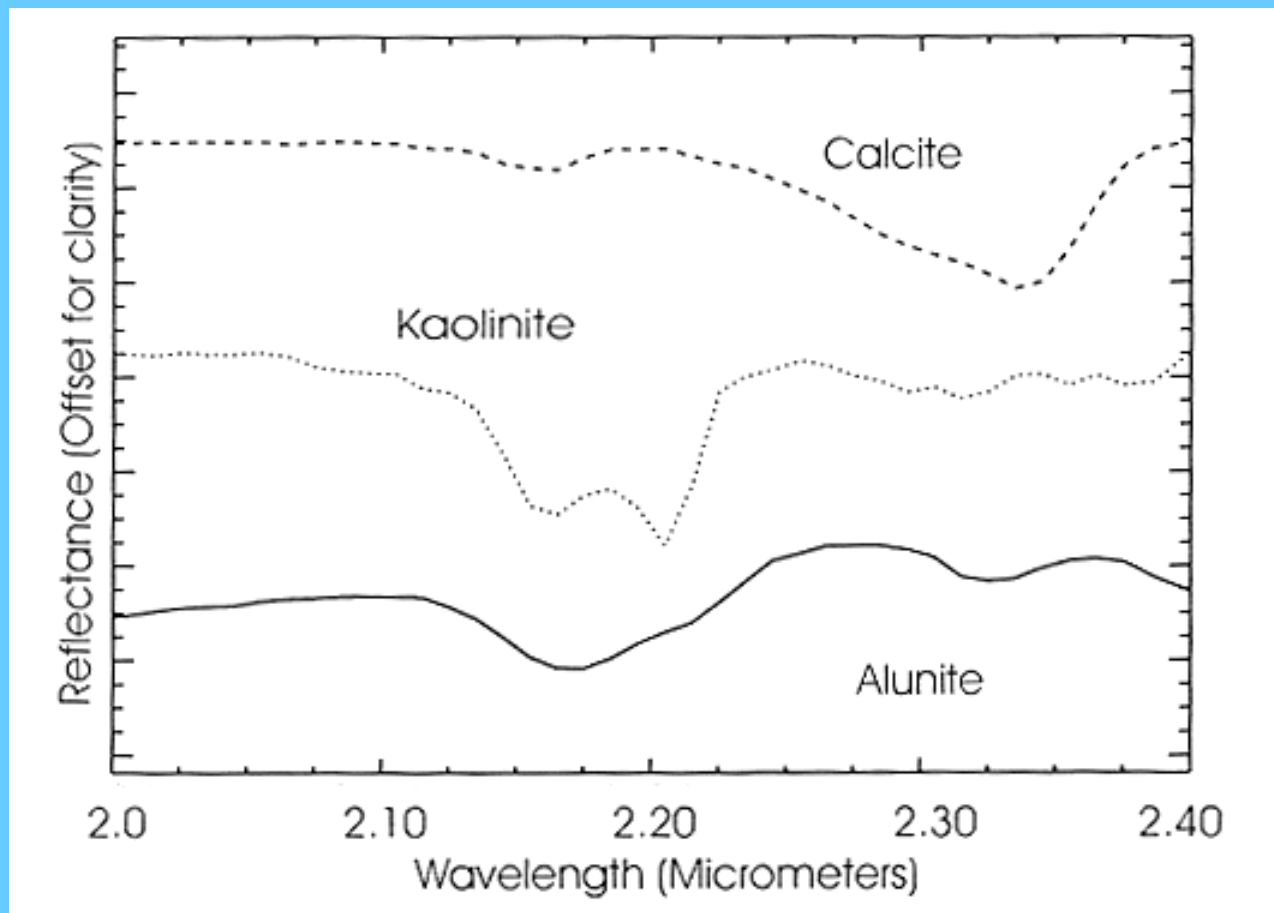

# Radiant properties of landscape objects - surfaces without vegetation - artificial surfaces

- concrete
- tar
- asphalt

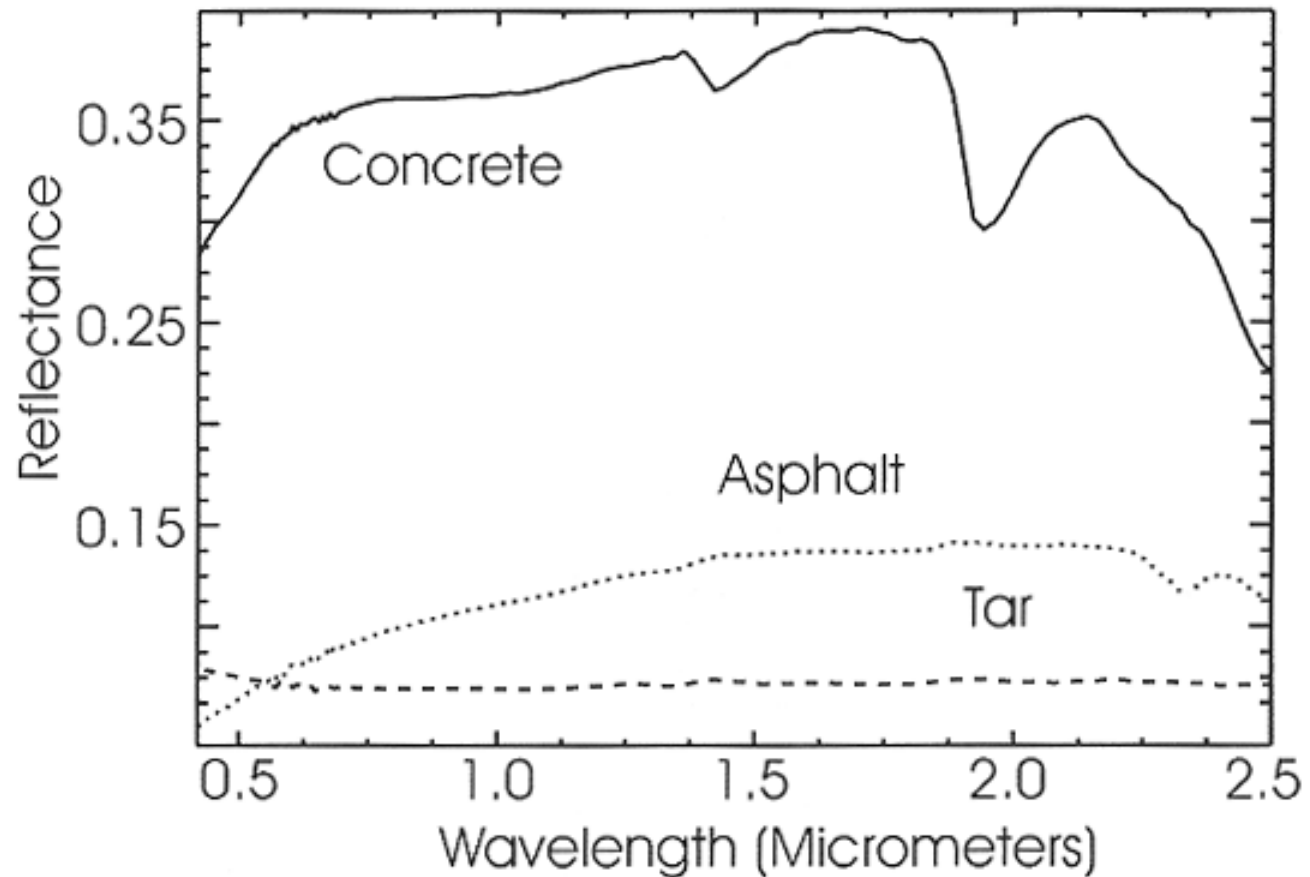

# Data Acquisition



# Data acquisition - types of instruments

- Measurement of the amount of radiant energy in reflected or emitted radiation from parts of the Earth's surface
  - 1. Registration - chemical change of a compound caused by incident energy (light) - *photographic cameras*
  - 2. Regular reading of electrical quantities - different variants of *radiometer*
  - ***There are passive instruments (measuring reflected solar or emitted radiation from an object) and active instruments (emitting their own artificial radiation - radars and lidars)***

# Data Acquisition - Measurement Conditions

- it is necessary to know the measurement conditions -
  - Time point of the solution
  - Wavelength or wavelength range of measurement
  - Polarization
  - Place of measurement
  - Measurement angle

# Data Acquisition

- The result of the measurement depends on the geometrical arrangement of the measurement - these parameters are collectively referred to as **instrument parameters**
- Measurement in the polarization plane - only for radar instruments

# Data Acquisition - Multispectral Measurements

- Measurements taken over a certain wavelength interval - **spectral measurements**
- **Multispectral measurement** - measurement at multiple intervals
- **Spectral resolution of the instrument** - number and width of bands

# Data Acquisition - Multispectral Measurements

- 2 types of multispectral measurement
  - **parallel measurement** - radiation measured in different wavebands simultaneously
  - **Sequential measurement** - radiation is measured sequentially - the location cannot be changed during the measurement period - it is a measurement from 1 location = **stationary measurement**

# Data Acquisition - Types of Measurements

- **Stationary measurements** - in practice, measurements at a large number of locations that cover a continuous area - this can be done using photographic cameras
- Radiometers - necessity to change the position of the instrument or its geometrical arrangement = **non-stationary measurement**

# Data Acquisition - Scanner

- **Profile (tracing measurement)** = change of the measurement point along the line = **radiometer (tracing radiometer)** placed on a movable carrier
- **Area measurement** (similar to photography) = **imaging scanning radiometer** = **scanner** - measuring radiation along the direction of motion of the carrier and across its motion

# Data Acquisition - Pixel

- **Spatial (geometric) resolution of the instrument** = the size of the area from which the electromagnetic energy is measured - a numerical value in a certain spectral band that represents 1 pixel (the size of a pixel on the Earth's surface)
- For photographic cameras, the resolution is determined by the number of resolvable lines per 1mm



# Data Acquisition - Media

1. Aircraft
2. Satellites
3. Others - balloons, drones, etc.

The data of photographic cameras is recorded directly on the medium

The data in scanners is usually transmitted by radio to the receiving station, where it is recorded

# Data acquisition - radiometer

- **Basic elements of a radiometer** (non-photographic method)

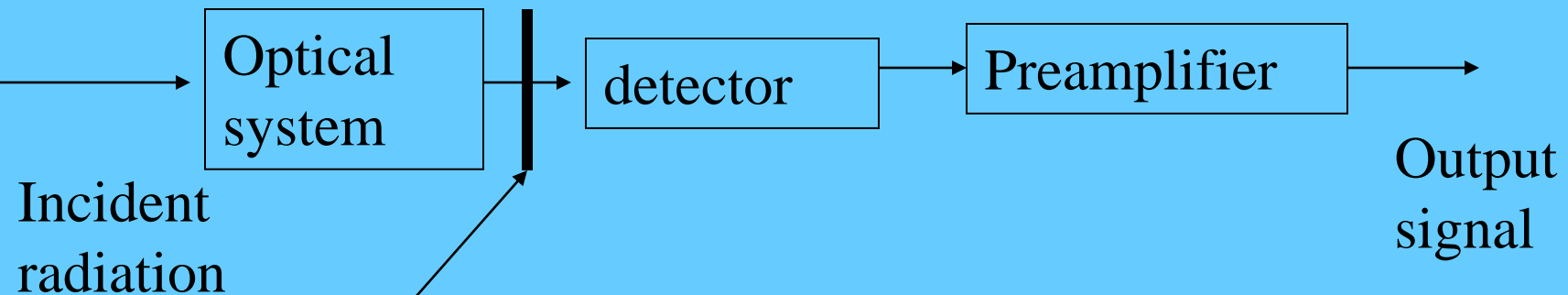

- **The optical system** consists of lenses or mirrors
- **Spectral divider** defines individual bands from the spectrum

# Data acquisition - radiometer field of view

- rd - radius of the detector
- ra - radius of optics or field of
- r - radius of the circle  
defined by the line of sight  
field
- h - height of the radiometer  
above the terrain
- fo - focal length of lens

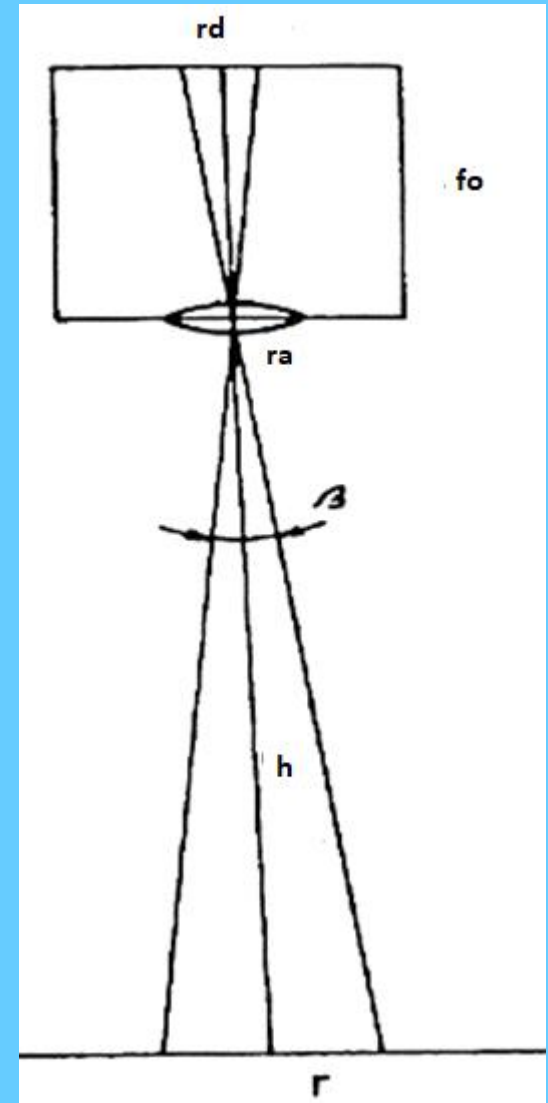

# The origin of the image

Photogrammetry is concerned with extracting measurement information from an image - this is captured by a **detector**

$$M = S^E$$

where  $E$  is the number of elements,  $S$  is the number of possible states of one element and  $M$  is the total number of states (number of combinations). A unit of information is defined as the amount of information needed to write two different states of one element:

$$\log_2 M = E \cdot \log_2 S$$

where  $\log_2 M =$  amount of information [bit], (1byte=8bits). The basic unit of a digital image is the **pixel** (from the English *picture element*).

## **Principle : capturing radiation**

$$E = h \cdot \eta$$

### **Detectors:**

- thermal -phonic**
- integral -quantitative**

$$Q = \Phi \cdot t \qquad \Phi = \frac{dQ}{dt}$$

where  $Q$  is the radiant energy,  $\Phi$  is the radiant flux and  $t$  is the *time*,  $h$  Planck const.,  $\eta$  frequency

# Data acquisition - spectral measurements

- Measurements in several to dozens of bands
  - spectroradiometers
- Measurements in hundreds of bands
  - hyperspectral scanners
    - the greater the number of narrow bands, the more accurate the measured information

Radiation decomposition - by prism,  
- grid,  
- optical filters.

# Film material

**The principle of photography** - the sensitivity of silver halides to light

- silver halides, supplemented with other compounds (dyes) are dispersed in a colloidal gelatine solution
- light decomposes unstable halides into  $\text{Ag}^+$  and halons (powdered silver is black)
- **a latent image** is formed - the developer and fixer terminate the processes (the amount of reduced silver determines the intensity of the incident light)

# Data Acquisition - Film Material

- a) **Black and white material** - different sensitivity to different wavelengths
  - **Unsensitized** blue sensitive
  - **Orthochromatic** insensitive to red
  - **Panchromatic** - sensitive to V radiation
- b) **Colour** - three-layer with colour pigments - principle of additive colour composition
  - **Infrared** - sensitive to red and near IR
  - **Spectral** - sensitive to near IR - false colour image

# The origin of the image

## Photographic material

In general, photographic material can be divided into:

**positive material, negative material and inverse (slide) material.**

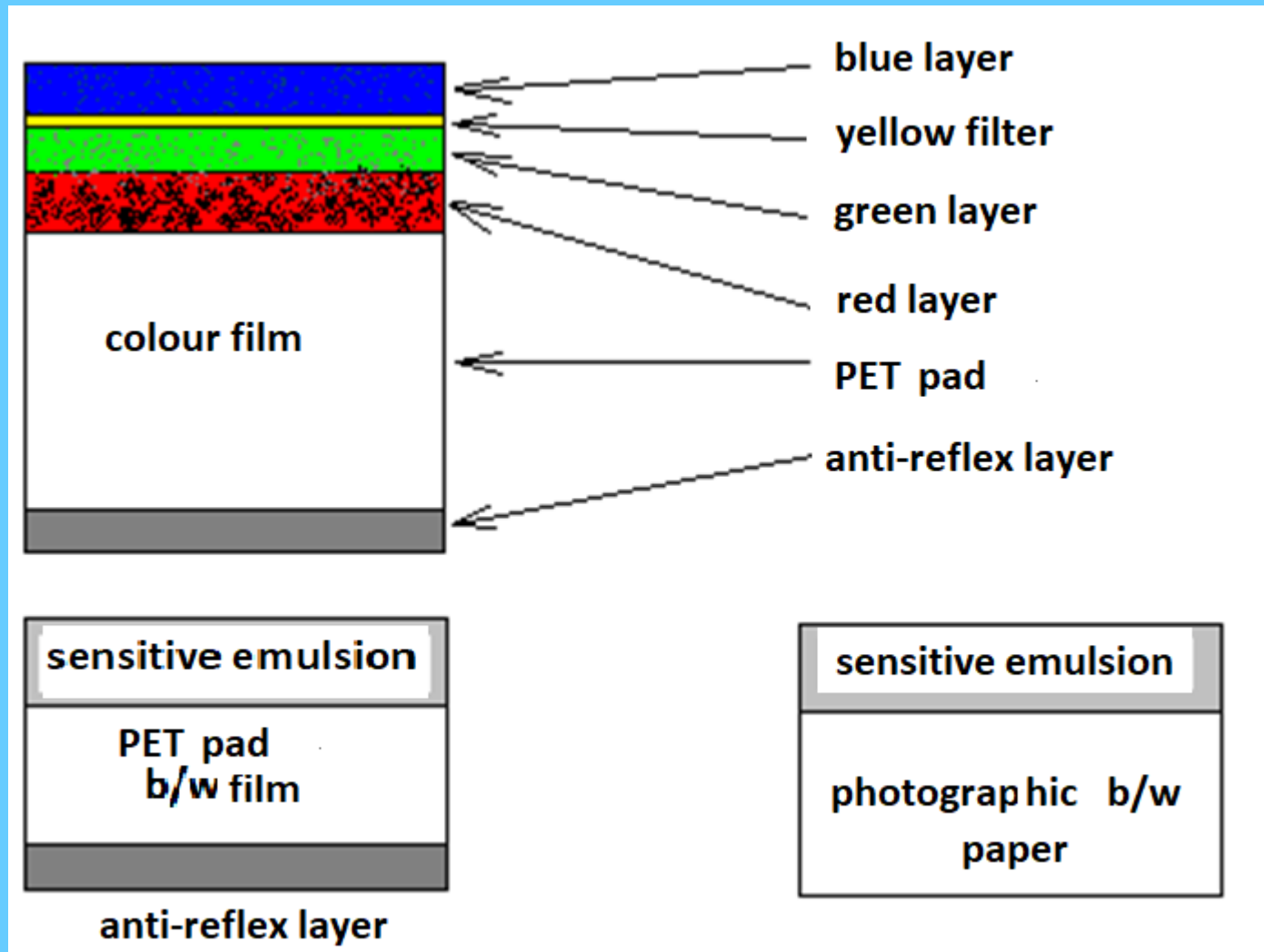



# The origin of the image

- **general sensitivity**

$$100ASA = 21DIN$$

$$200ASA = 24DIN$$

$$400ASA = 27DIN$$

- **gradations**

• indicates the relationship between the amount of light and the degree of blackening of the sensitive layer, or the blackening rate at constant illumination. The dependence of blackening on exposure is given by *the sensitometric curve*.

- **Resolution (ReS)** /mm

$$ReS_{max} = \frac{1000 \cdot A}{2.4 \cdot \lambda \cdot f}$$

$f/A$	2.8	8.0	32.0
$RS_{max}$ (line/mm)	298	83	26

# Sensitometric curve

$$T = \frac{\Phi_{\text{Passing}}}{\Phi_{\text{Emitted}}}$$

where  $\Phi$  is luminous flux,  $T$  is transmittance,  $1/T$  is called transparency

$$D = \log\left(\frac{1}{T}\right) = -\log(T) \quad D \text{ is the density (optical density, degree of blackening).}$$

$$E = \frac{\Phi}{S}$$

$E$  is the illuminance [lux],  $S$  is the illuminated area.

$$H = E \cdot t$$

$H$  is the exposure and  $t$  is the time (the exposure time).

$$G = \frac{\Delta D}{\Delta \log(H)}$$

# The origin of the image

$$G = \operatorname{tg}(\gamma)$$

*gradation (steepness) G*

Gradation is a linear gradient  
parts of the sensitometric curve

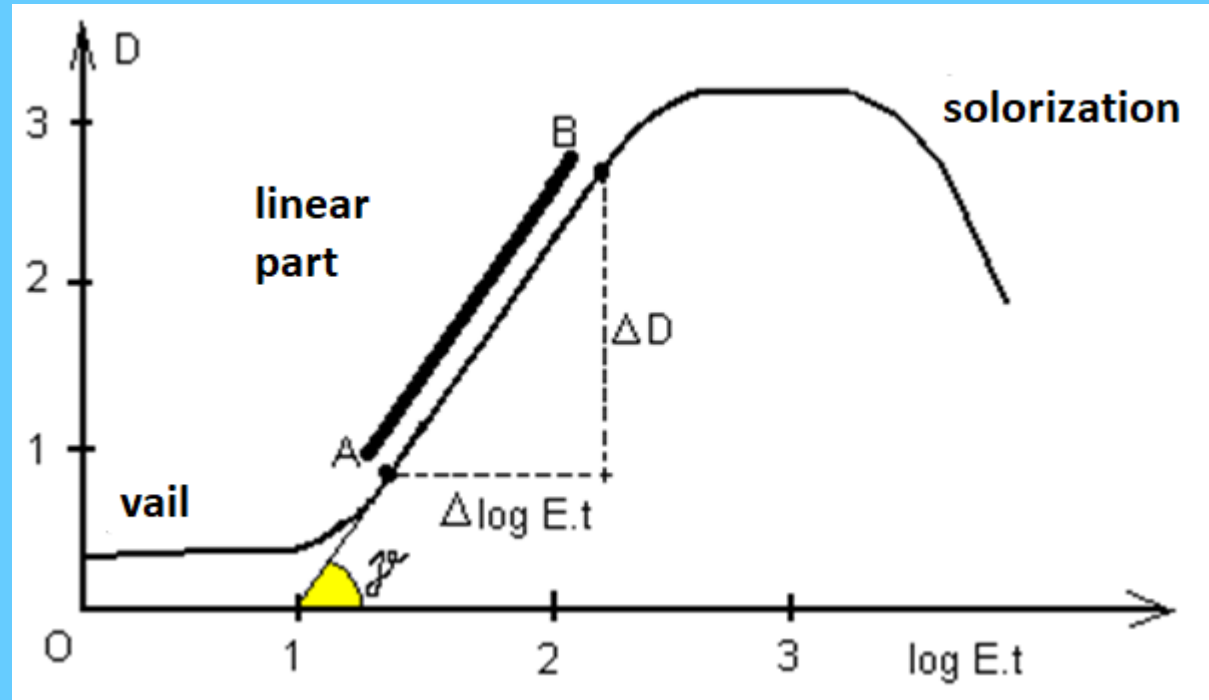

$G < 1$  ...(<45) ...soft working material

$G = 1$  ... (=45) ...normal working material

$G > 1$  ...(>45) ...steep working material (hard)

# The origin of the image optical density measurement

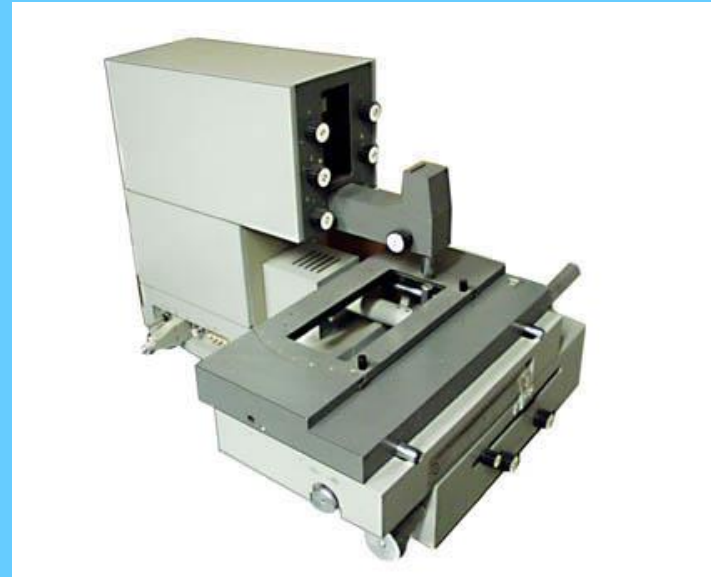

*Densitometer Meodenzi TRD01-Meopta (left), Zeiss Jena MD100 (right)*

# The creation of the digital image

**A digital image is an image in digital form (expressed in numbers).** It is created either primarily by digital capture devices or by scanning analogue images. A digital image consists of individual pixels (from the English *picture elements*) taking on certain values which are not arbitrary (determined by the technical possibilities of the computer and the coding).

Image size:

$$M = m \cdot n \cdot e \text{ [byte]}$$

The so-called image function describes the pixel value:  $P[i, j] = f(i, j)$

$f(i, j)$	$f(i, j+1)$	$f(i, j+2)$	$f(i, j+3)$	$f(i, j+4)$
$f(i+1, j)$	$f(i+1, j+1)$	$f(i+1, j+2)$	$f(i+1, j+3)$	$f(i+1, j+4)$
$f(i+2, j)$	$f(i+2, j+1)$	$f(i+2, j+2)$	$f(i+2, j+3)$	$f(i+2, j+4)$
.....				
.....				$f(m, n)$

# Sensors principle

The most common type of detector is the **CCD** element. The name is derived from the name of the element in English "*Charge Coupled Device*".

**CMOS** (*Complementary Metal Oxide Semiconductor*) is a transistor-based electronic component. Compared to a CCD, it is simpler to manufacture, smaller, up to 80% cheaper, and consumes less power than a CCD (only 1%!).

**Photocell** - the principle of its function is generally the same with CCD detectors, differing mainly in size

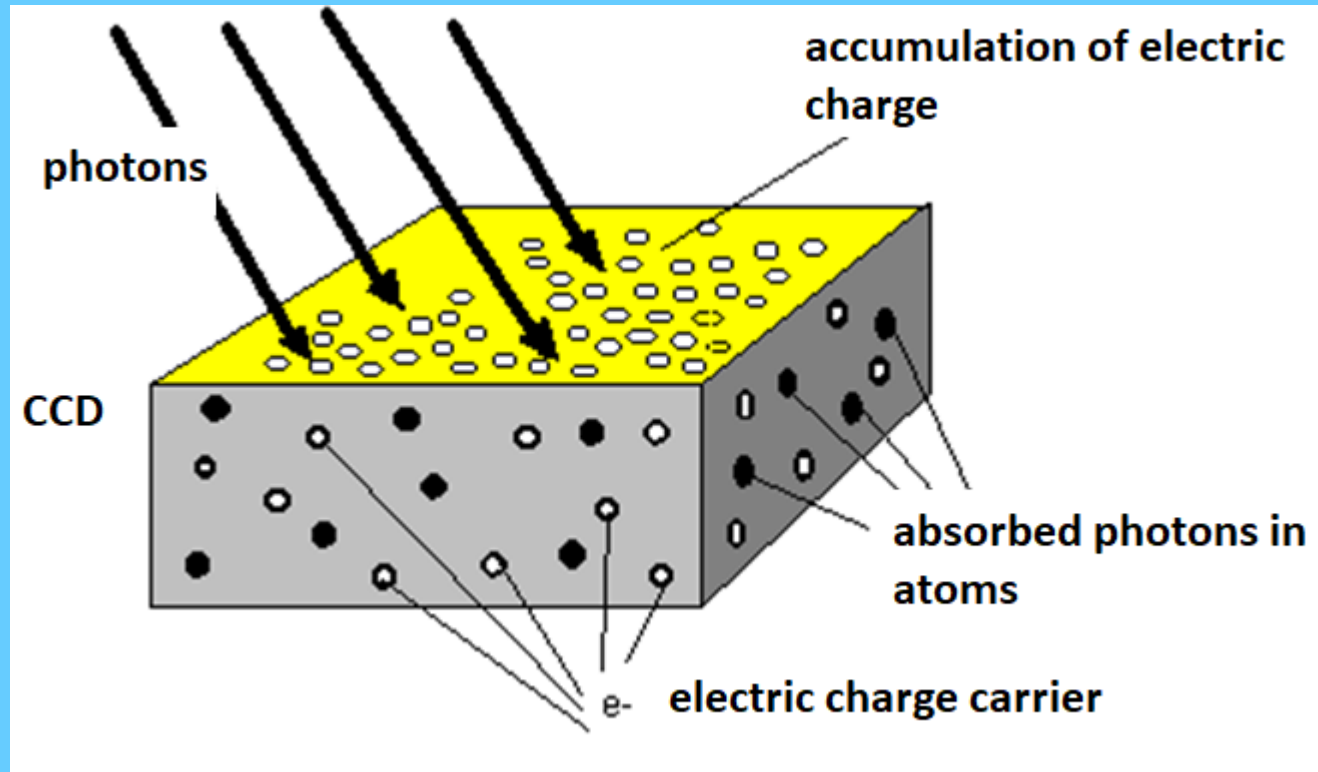

# The creation of the digital image - electronic sensors

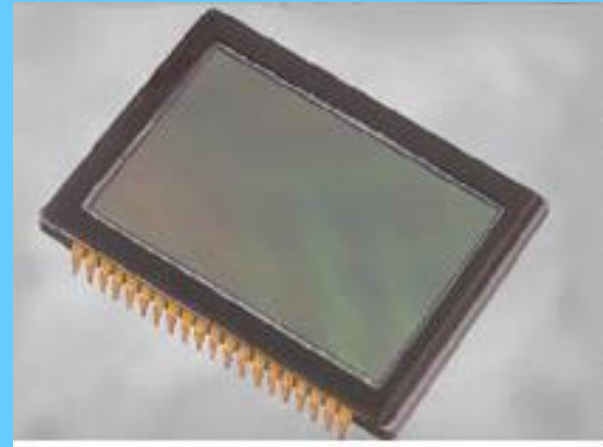
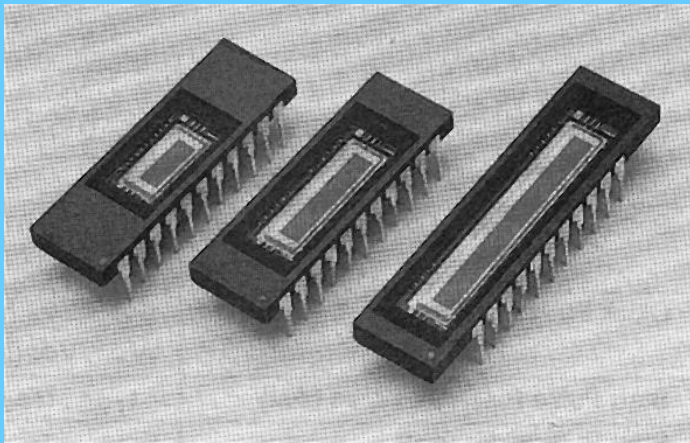

**Linear and matrix**

# Creation of the digital colour image

Tree pass camera

Three-sensor camera

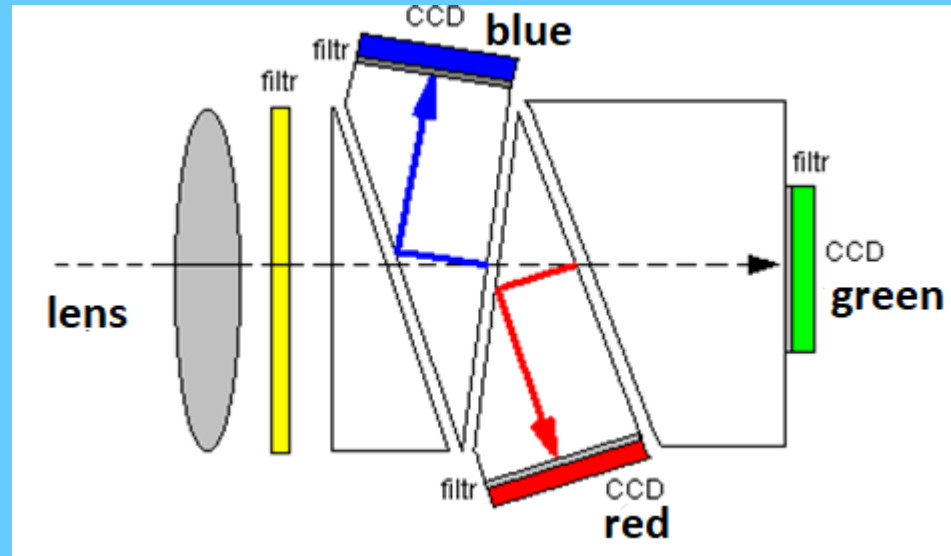

Single sensor (*one shot camera*)

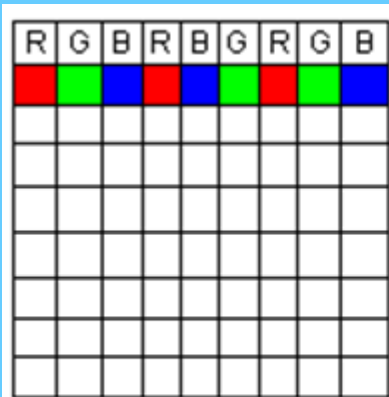

RGB linear mask

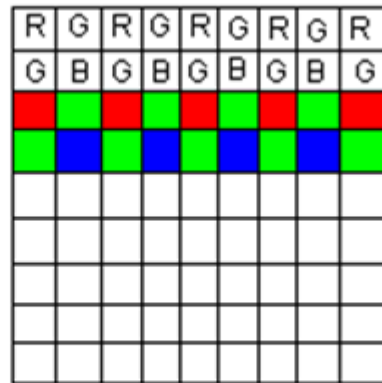

RGBG mosaic mask

white light

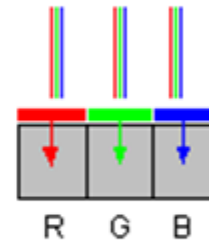

white light

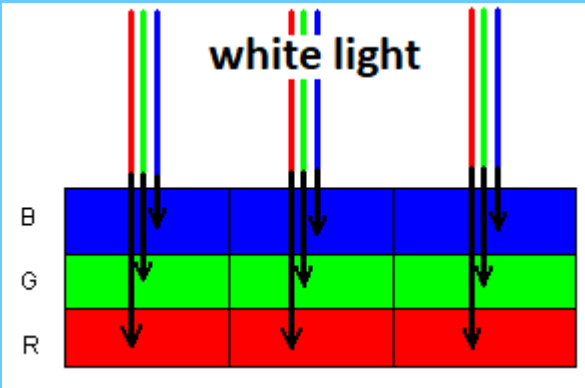



# Photogrammetric cameras



Leica RC 30 camera

Zeiss RMK-TOP camera and  
TAS gyrostabilised platform



LMK camera (Zeiss Jena)

# Classical photogrammetric records

*fiducial marks*

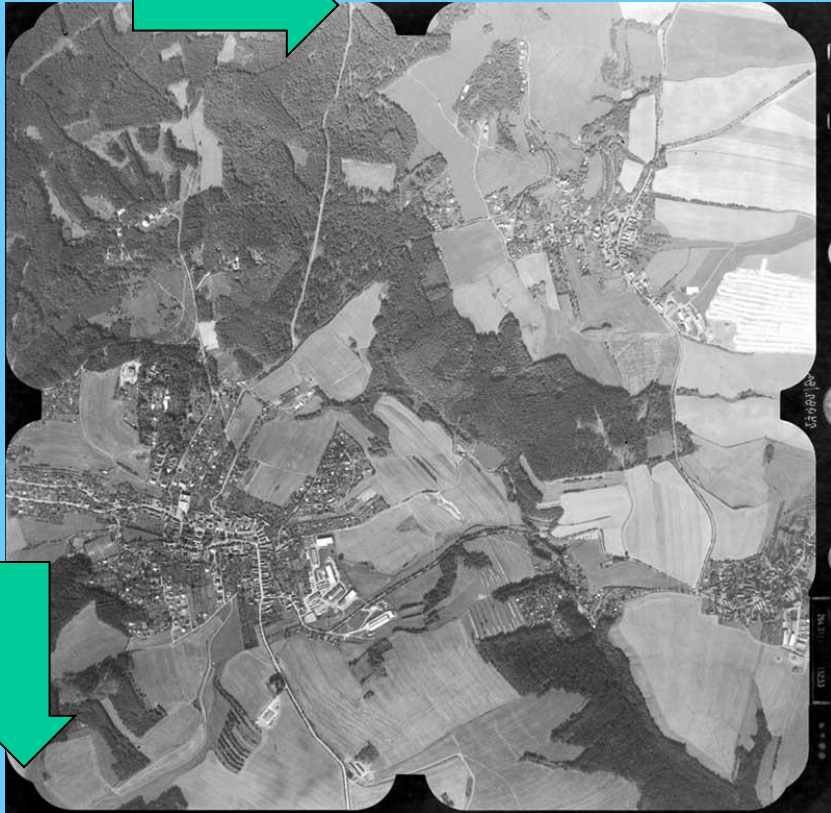

# Data Acquisition - Calibration

- **Ground calibration** - before use on the satellite - internal calibration of the system is established - a difficult task in terms of a suitable stable radiation source
- For calibration of the satellite spectroradiometer - **comparative ground** measurements must be used
  - the influence of the atmosphere must be taken into account

# Data Acquisition - Imaging Instruments

- Creation of planar image data - it is necessary to switch from one-direction measurement (trace radiometer) to planar = two-direction measurement
- **Bidirectional measurement** - in the direction of flight and across - usually perpendicular, sometimes along part of a circle
- This method is called **scanning** = line scanning - the imaged data is arranged in the same spatial arrangement as the measurement - an image is created
- 2 types of scanners:
  - mechanical,
  - electronic.

# Data Acquisition

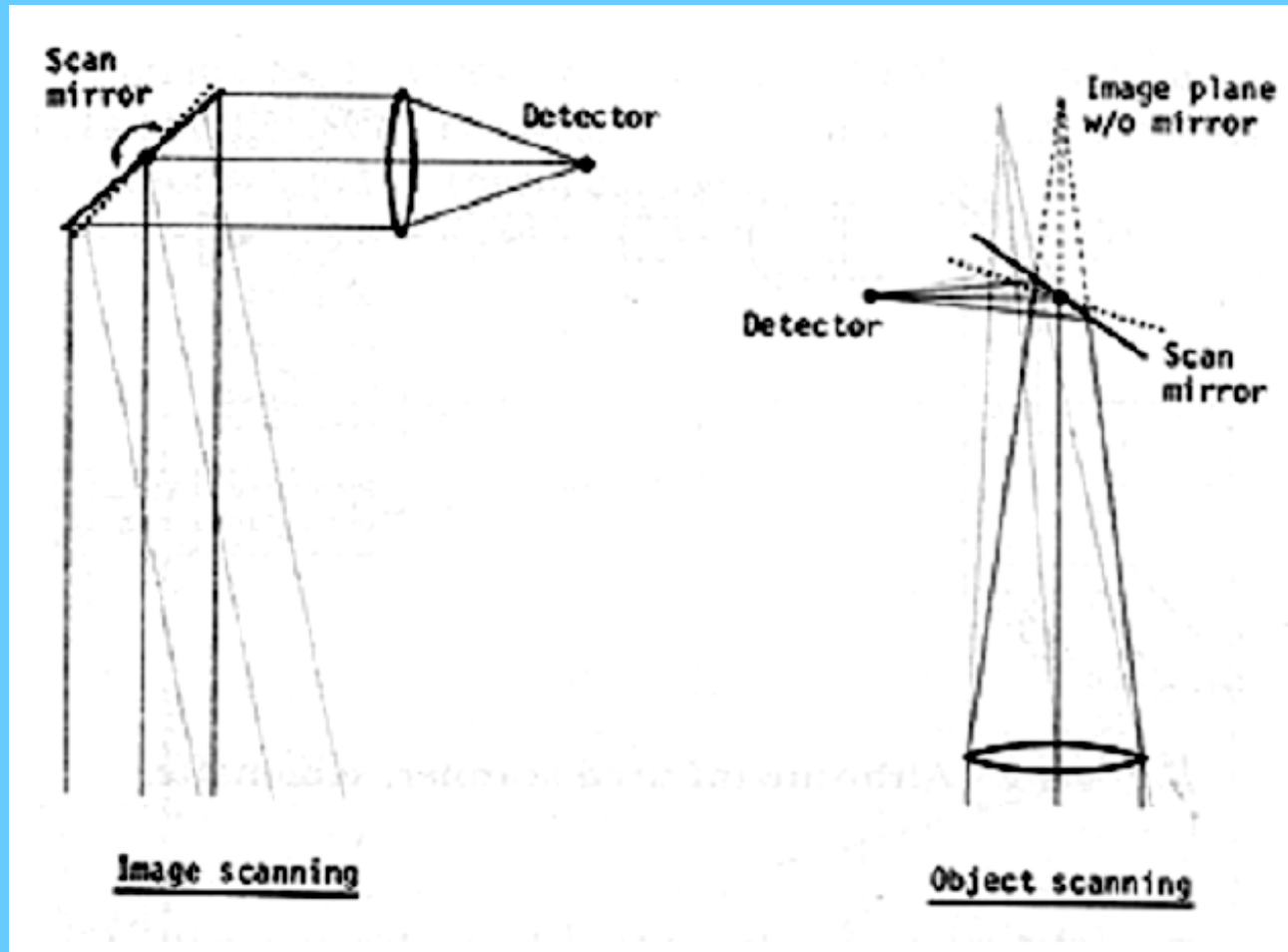

image scanner

object scanner



# Data Acquisition - Imaging Instruments

Geometry  
mechanical  
scanner

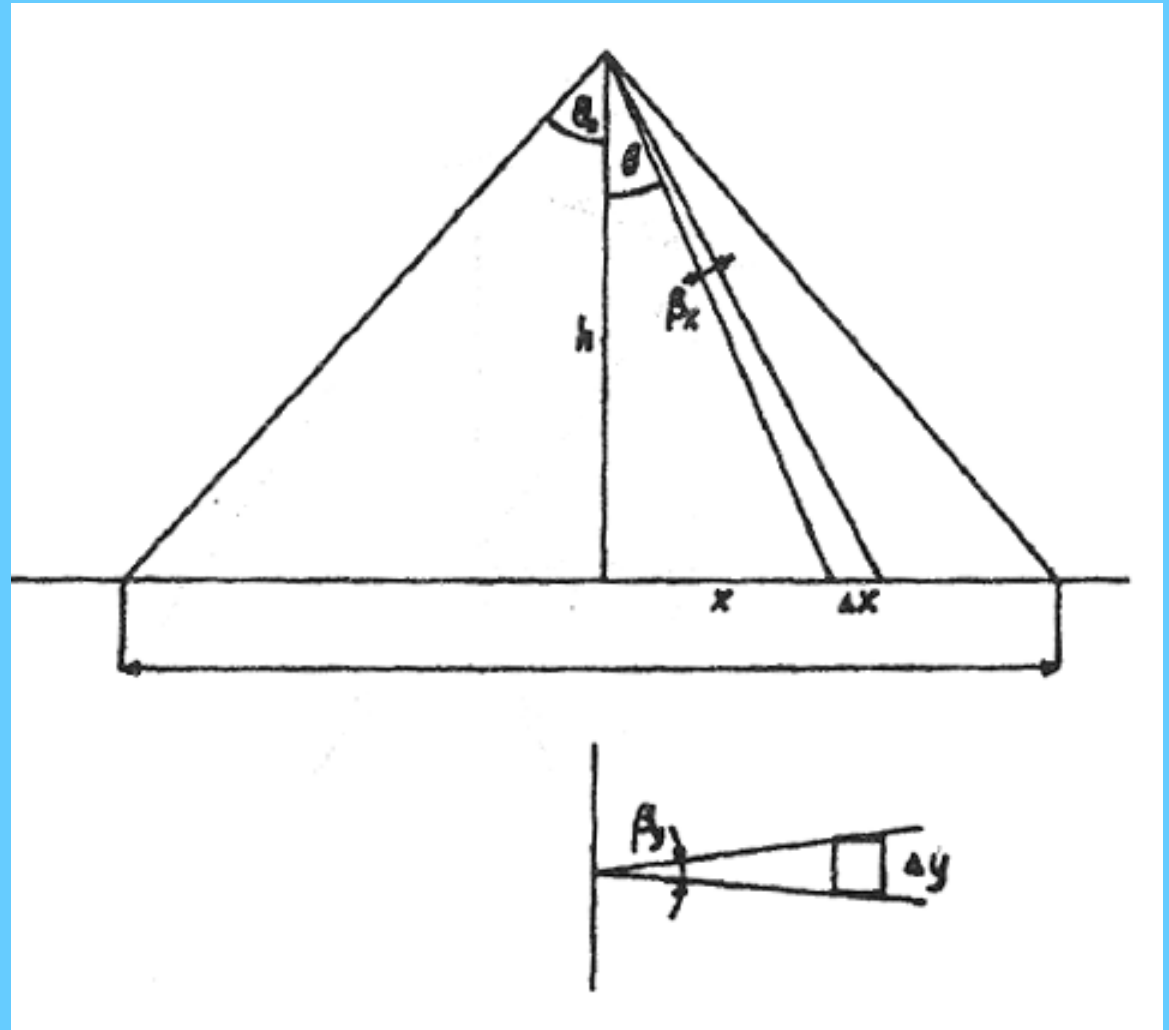

# Data Acquisition - Imaging Instruments

Mechanical scanner

Landsat MSS

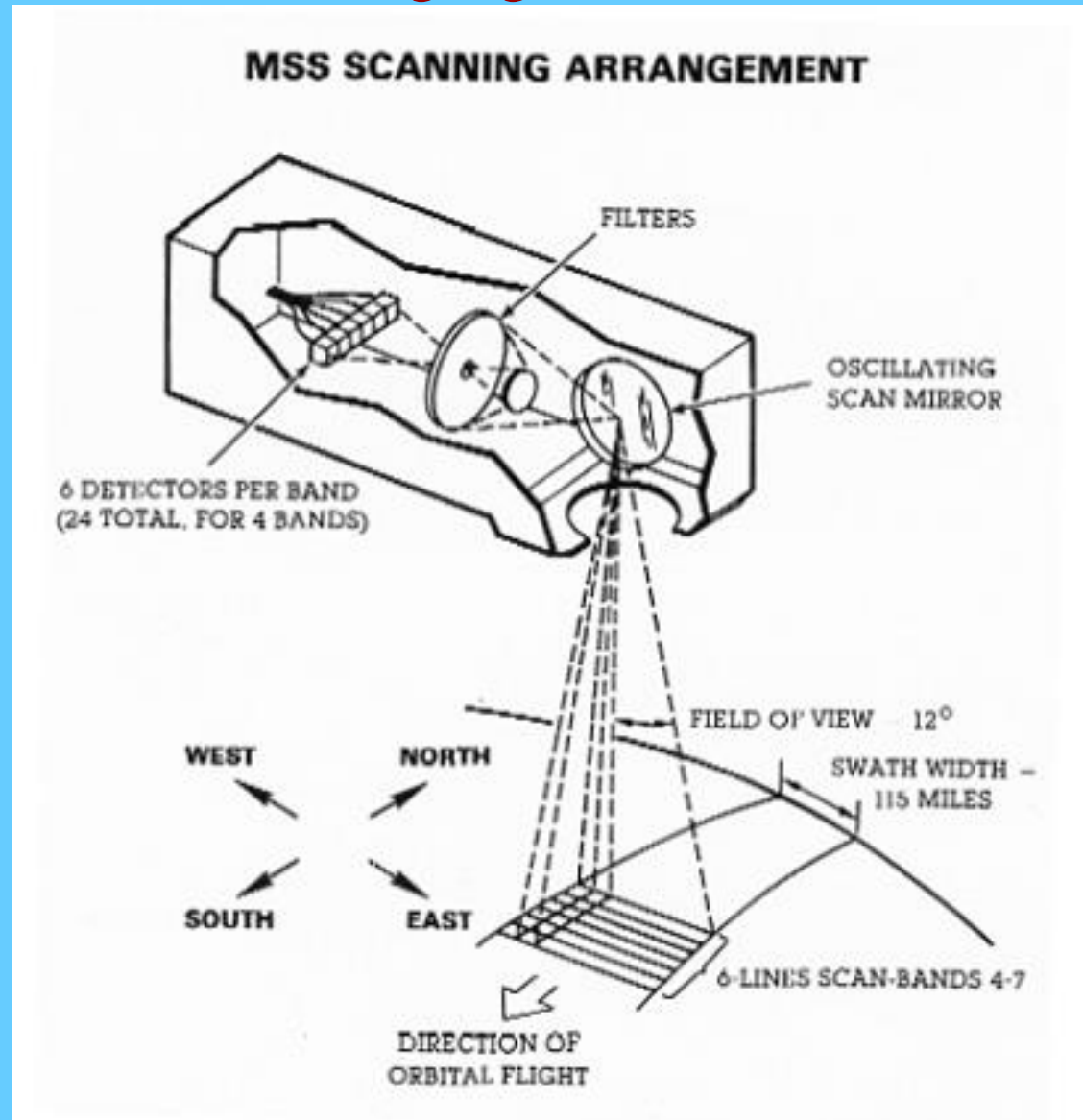

# Data Acquisition - Imaging Instruments

## Problems:

1. When scanning with large  $\theta$  angles, the pixel shape is stretched along the line
2. For angles  $\theta > 45^\circ$ :

Data recorded  
for angles  $\theta$  at the focal  
distances  $f_o$ , but  
displayed flat

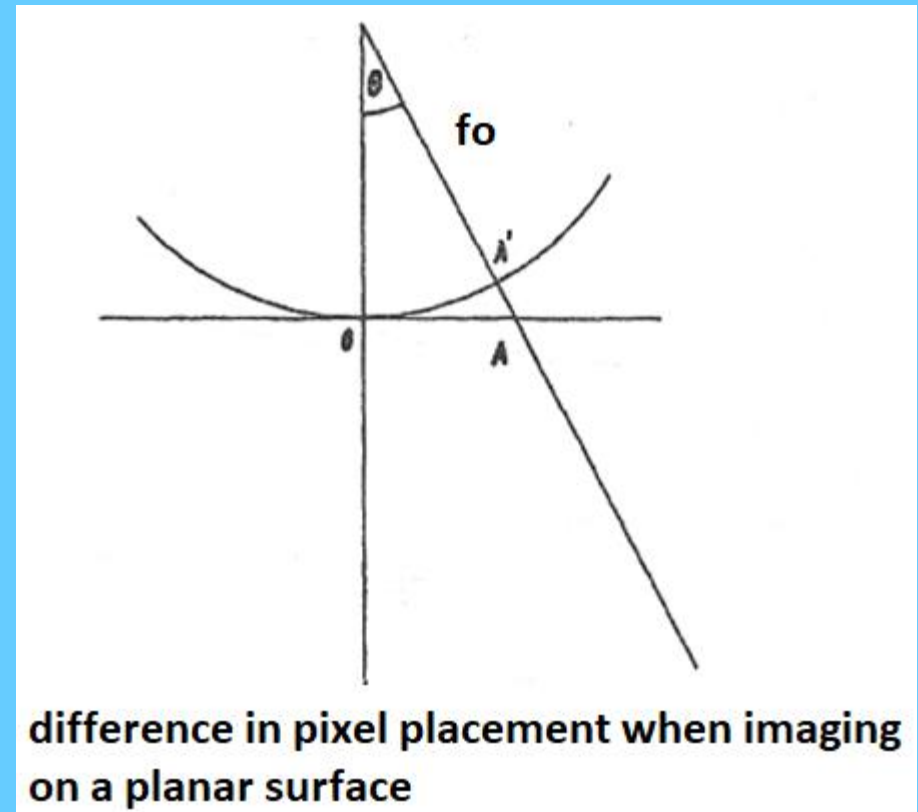



# Data Acquisition - Imaging Instruments

3. Effect of the curvature of the Earth - especially for meteorological satellites - large deformation (image collision) at the edges

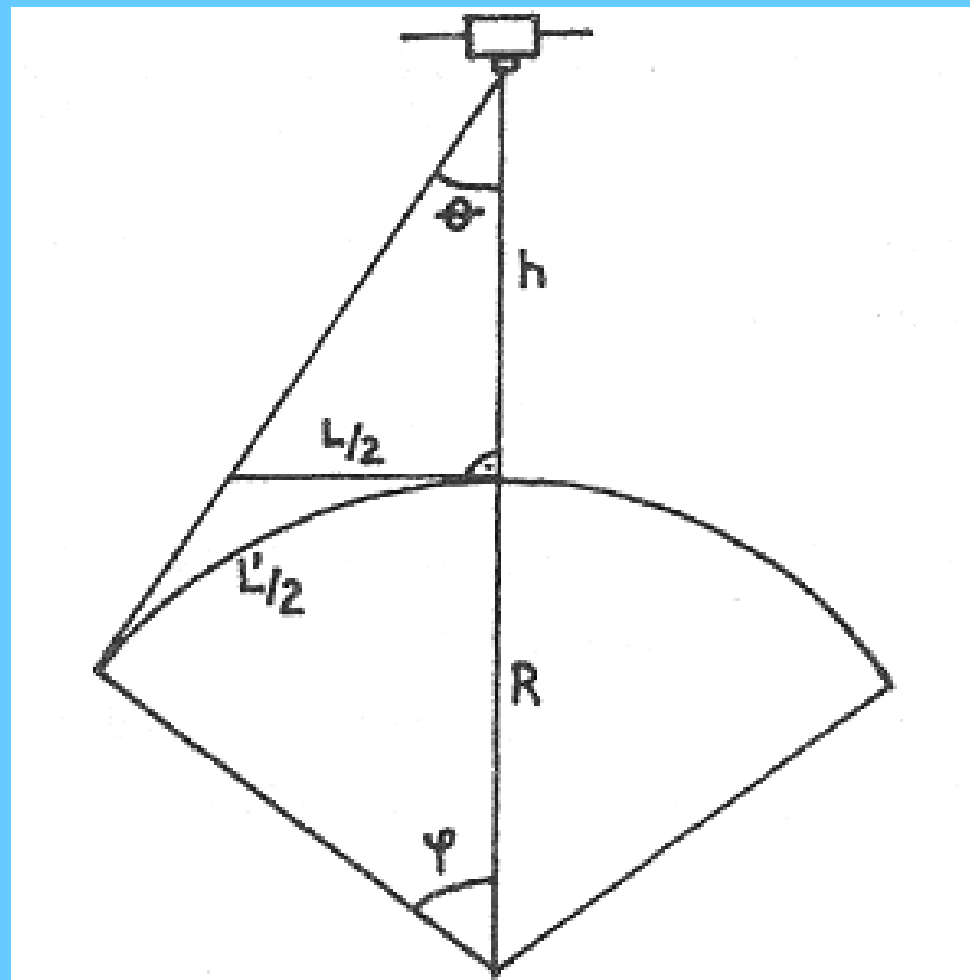

# Data Acquisition - Imaging Instruments

Electronic scanner = "wipe" scanner (push broom)

Instead of a mechanical scanner mechanism, a **line/matrix array of detectors** is created - these are placed in the focal plane of the optics - each sensor registers radiation from an area of 1 pixel - in the field of view of the scanner is the entire line, which is usually perpendicular to the direction of flight

# Data Acquisition - Imaging Instruments

Geometry  
electronic scanner

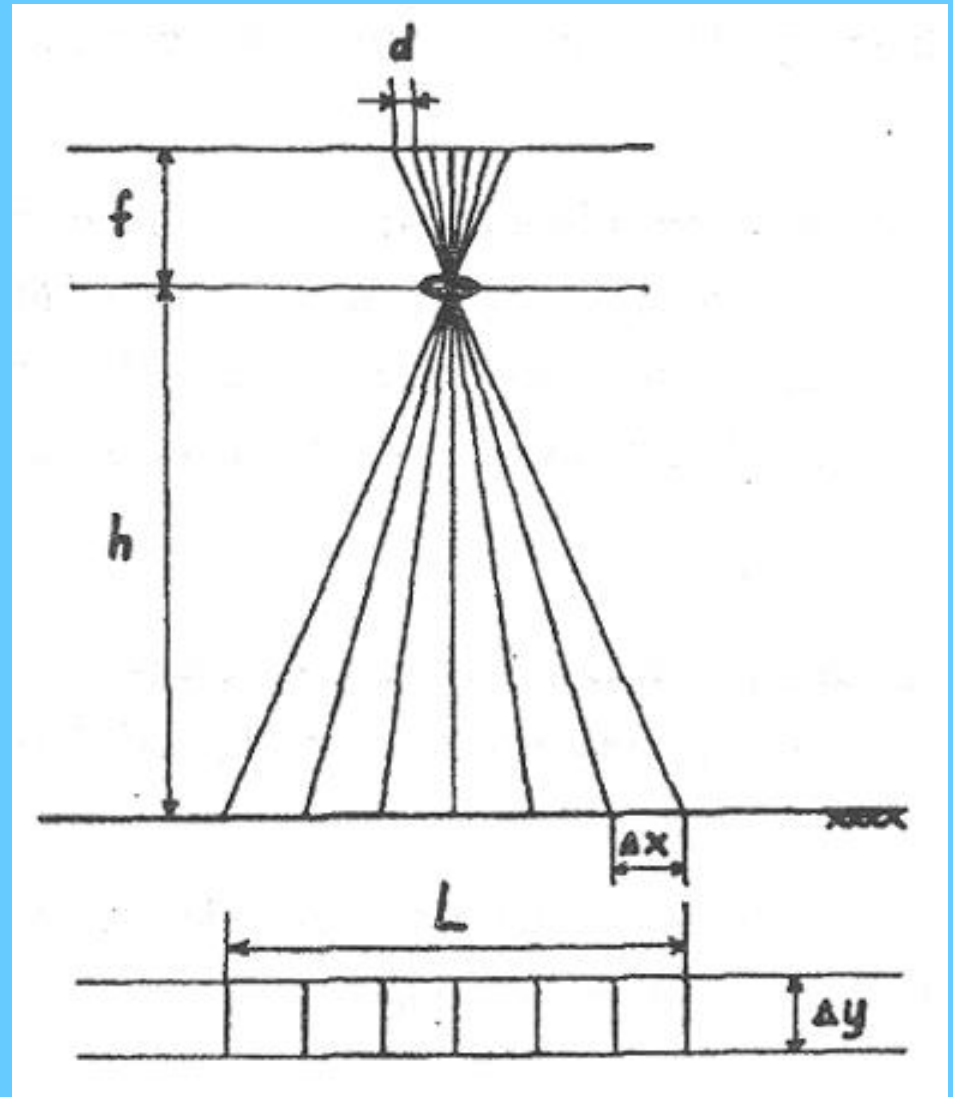

# Data Acquisition - Media

## Aircraft carriers

- Human Crew - Control
- Aircraft movement - source of errors - rotational movements around 3 main axes, wind drift, inaccuracy of altitude level maintenance
- the quality of flight control (GNSS/IMU) is constantly improving
- limited flight possibilities by the atmosphere

# Data Acquisition - Media

**Satellite carriers** = ideal carriers since the beginning of RS

- 1) Great height
  - small field of view
  - larger area of measured territory - up to thousands of km<sup>2</sup>
- 2 ) Repeatability of measurement - time resolution - days - to minutes

# Data Acquisition - Satellite Carriers

- possibility to ensure the same conditions of illumination by the Sun = the same angle of the Sun above the local horizon - rotation of the satellite's orbit = angular velocity of the Earth's motion - sun-synchronous orbits
- geostationary orbit- constantly over the same spot above the Earth's surface - high altitude - 36,000 km - satellite moves in the plane of the Earth's equator - much of the globe is distorted geometrically

# Type of orbits

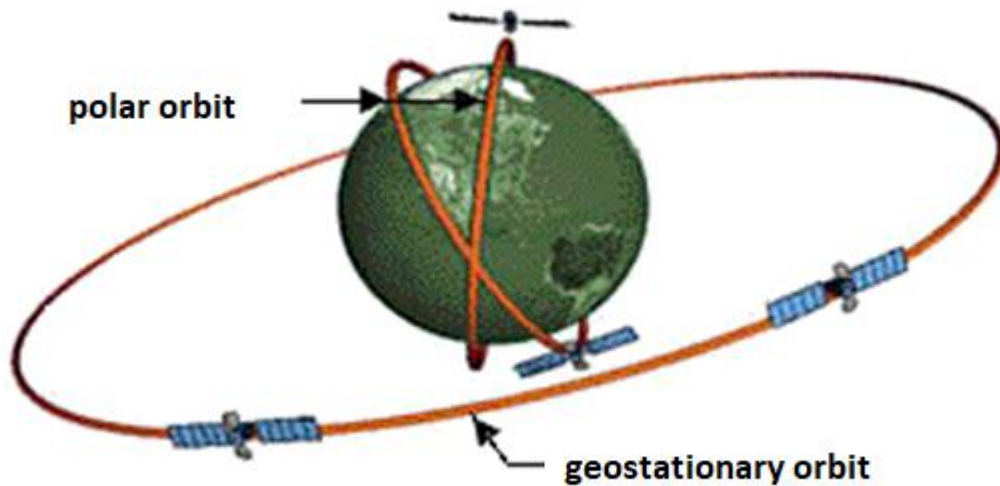
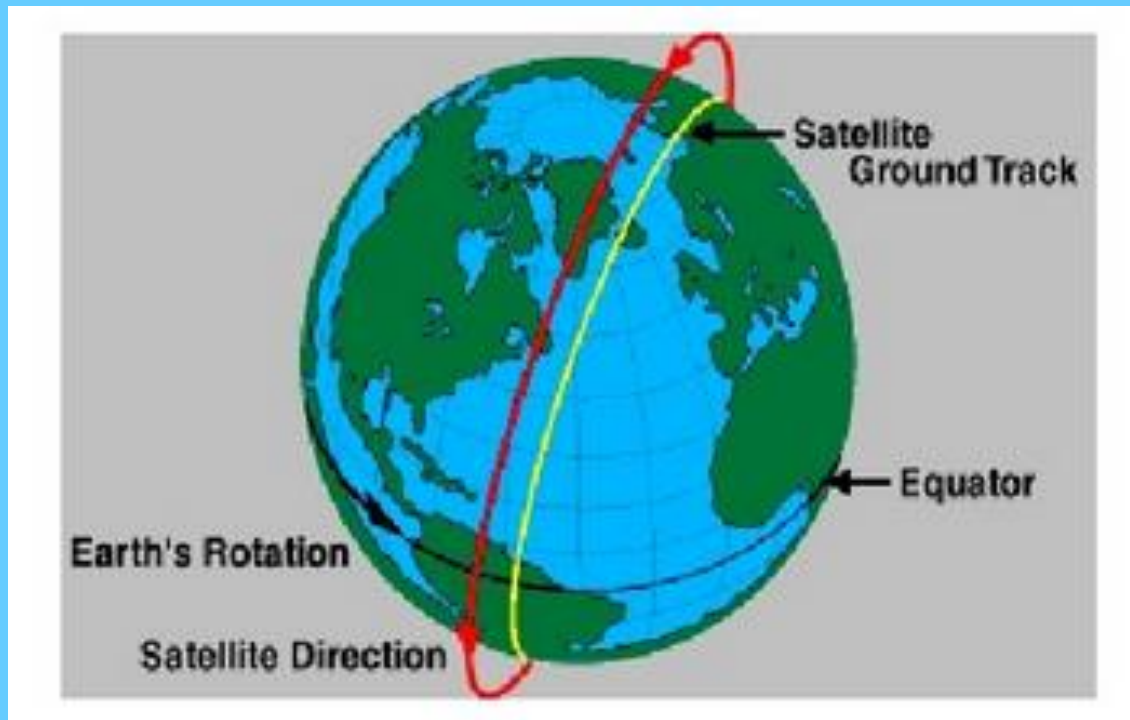

# Data Acquisition - Media

- 3) real-time measurement capability - data measured by the scanner is transmitted via radio to a ground receiving station within range - thousands of receiving stations - each satellite has its own
- If the satellite is not in range - the link satellites that are in geostationary orbit are used



# Data Acquisition

-the need for receiving stations on the Earth's surface



network of ground stations for receiving Landsat data

# Data Acquisition - Media

- Satellites are **stabilized** – (there are no significant distractions like with aircraft ) = higher quality of imaging and positioning than by aerial carriers; deviations from the desired position are minimal
- These satellites are equipped with an **active motor system** for attitude correction
- There are no atmospheric interferences (almost a vacuum, outer space)

# Data Acquisition - Media

Lifetime of satellites:

- Fuel (orientation motors) and working substances (coolant, etc.)
- Reliability of electronic systems
- Reliability of the measuring apparatus
- Runway height
- Power source

# RS data processing

# RS data processing

- Stage when information is obtained from the measured data
- Processing is a difficult process, it may not always represent the same solution procedure
- Different types of RS data are processed for different purposes

# RS data processing

- Unambiguous wording - must match data capabilities
- Data quality is a given:
  - technical measurement parameters
  - geometric arrangement of measurements
  - the state of the atmosphere
  - the intensity of the measured radiation source

# RS data processing - RS task formulation

- RS solves the relationship between the measured radiation quantity (radiant flux, radiation, radiation intensity,...) measured on the satellite and the species and state parameters of the substances in the measurement area
- 2 types of tasks - direct and indirect

# RS data processing - description

- Direct role:

Let all the internal measurement parameters  $s(x,y)$  and all the characteristics of the incident radiation be known at a given location. The problem is to determine the radiation quantities  $f(x,y)$  describing the radiation of the location



# RS data processing - description

- The reversed task

Assuming known values of the radiation quantity and known characteristics of the incident radiation, the task is to find a set of species and state parameters

In practice, the above problem is solved

# RS data processing - analogue processing

- Photogrammetric processing
- Special equipment for RS - densitometer, rectifier, mixing projector
- Visual interpretation

*MSP 4C Rectimat C*

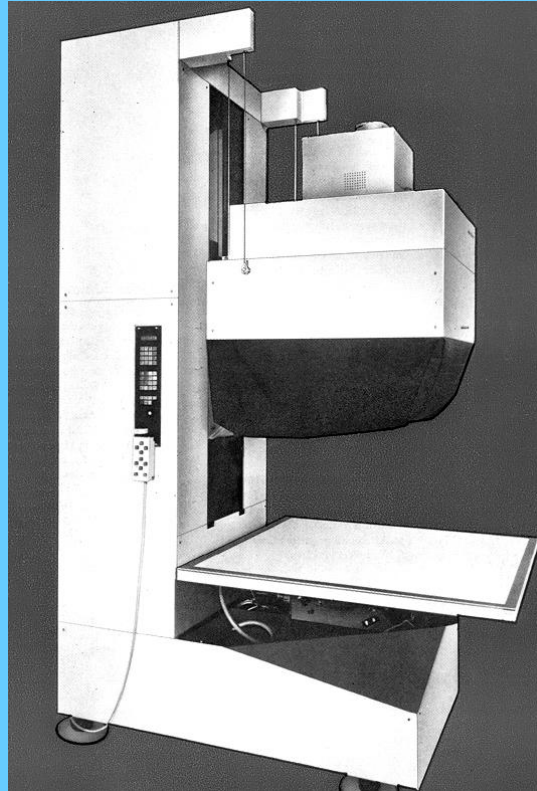

*multispectral camera MSK4*



# Digital image processing

# Digital image processing

- 4 basic tasks:

Rectification and restoration of the painting

Image Highlighting

Classification

Post-classification adjustments

# Digital image processing - image rectification and restoration

**Rectification** - used to convert to a coordinate system

Measured data - positional errors arising from:

- changes in carrier height
- the position of the carrier, its speed
- curvature of the Earth
- changes in carrier height (terrain irregularities)

# Digital image processing - image rectification and restoration

Different levels of rectification:

- None
- Determine the exact location of 1 point in the image
- Determine the 4 corner points
- Geometric transformation in 2D
- Orthogonal transformations

# Digital image processing - image rectification and restoration

- Geometric transformation in 2D:

There are

- 1) Image data without coordinate system
- 2) Map base (e.g. vector data)

Principle - find matching pairs of inflection points to determine the transformation equations

# Digital image processing - image rectification and restoration

- $x, y$  - map coordinates
- $X, Y$  - coordinates of the uncorrected image

$$X = f_1(x, y)$$

$$Y = f_2(x, y)$$

- $f_1(x, y), f_2(x, y)$  - **transformation equations** -  
polynomials of different order



# Digital image processing - image rectification and restoration

- Polynomial of (e.g.) 1st order:
  - shift, rotate, scale change - at least 3 pairs of insertion points

$$X = a_0 + a_1x + a_2y + a_3xy + a_4x^2 + a_5y^2 + a_6x^2y + a_7xy^2 + a_8x^3 + a_9y^3$$

$$Y = b_0 + b_1x + b_2y + b_3xy + b_4x^2 + b_5y^2 + b_6x^2y + b_7xy^2 + b_8x^3 + b_9y^3$$

----- 1st order polynomial

----- polynomial 2.order

----- 3.order

# Digital image processing - image rectification and restoration

It is necessary to define the **output matrix of**  
the corrected image

It is necessary to determine the **digital pixel**  
**values in** the corrected image

# Digital Image Processing -

rectification and  
image restoration

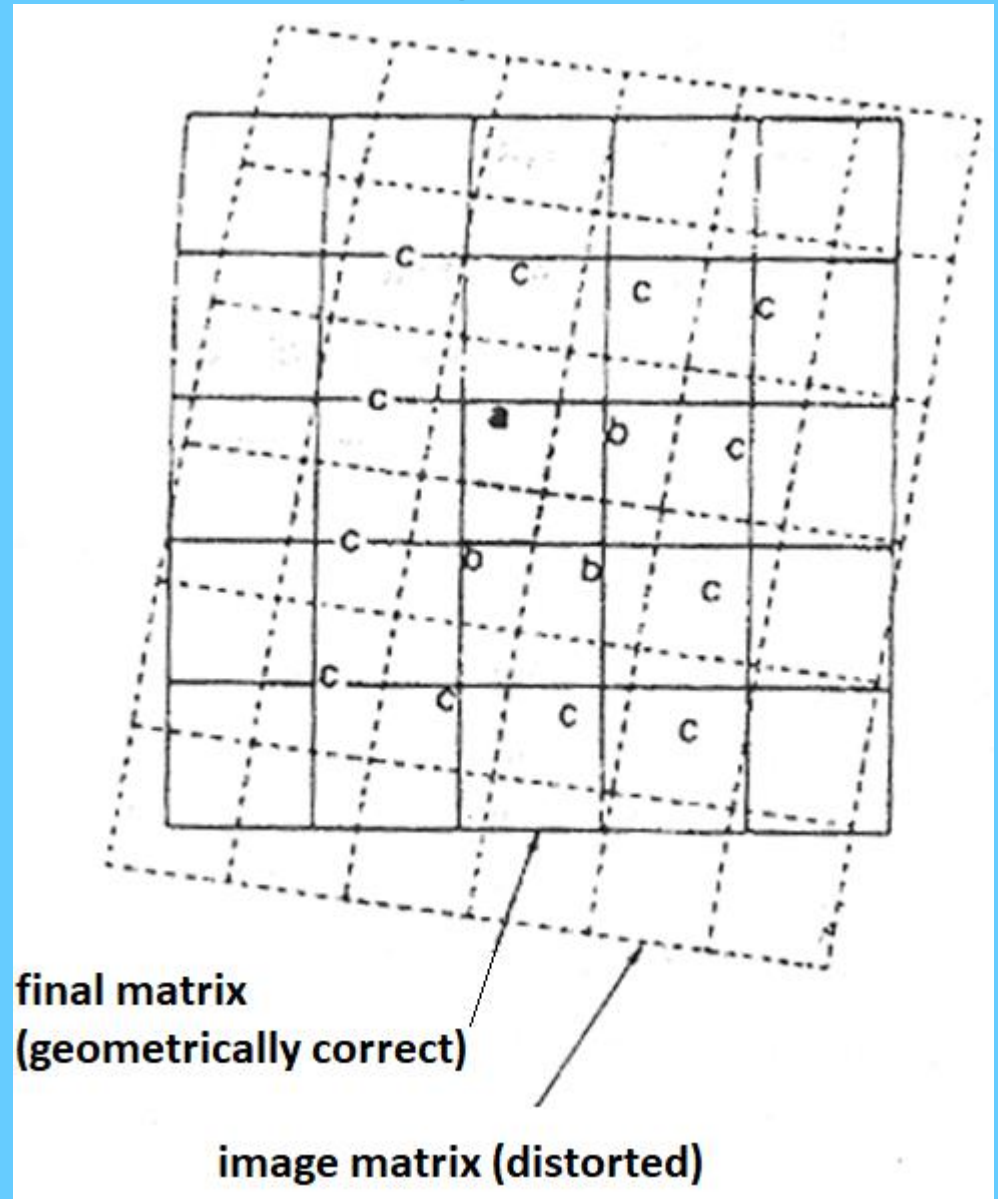

# Digital image processing - image rectification and restoration

- Method of calculating new **DV in pixels**:
  - nearest neighbour method - default value
  - by the bilinear transformation method

$$f = \frac{A.f(a) + B.f(b) + C.f(b) + D.f(b)}{f(a) + 3.f(b)}$$

Where a - DV (digital value) of the nearest pixel

b - DV of the three nearest pixels

A, B, C, D weight functions by distance

**Cubic convolution method** - 16 nearest pixels enter the calculation

# Digital image processing - image rectification and restoration

**Image restoration** = correction of radiometric values resulting

- from **instrument calibration**
- from **changes in radiation exposure** at different times of the year, at different times of the day
- from **flight geometry** - change in angle of irradiation in one line
- from the **state of the atmosphere**

# Digital Image Processing - Image Highlighting

**Image highlighting**= enhancement to find the most information contained in the data important because the sensitivity of vision is less than the range of most measured data

# Digital Image Processing – Image Highlighting

1. **histogram stretching** - linear, non-linear

**Point highlight methods** = methods that do not consider values around pixels – for human visualisation only

# Digital Image Processing - Image Highlighting

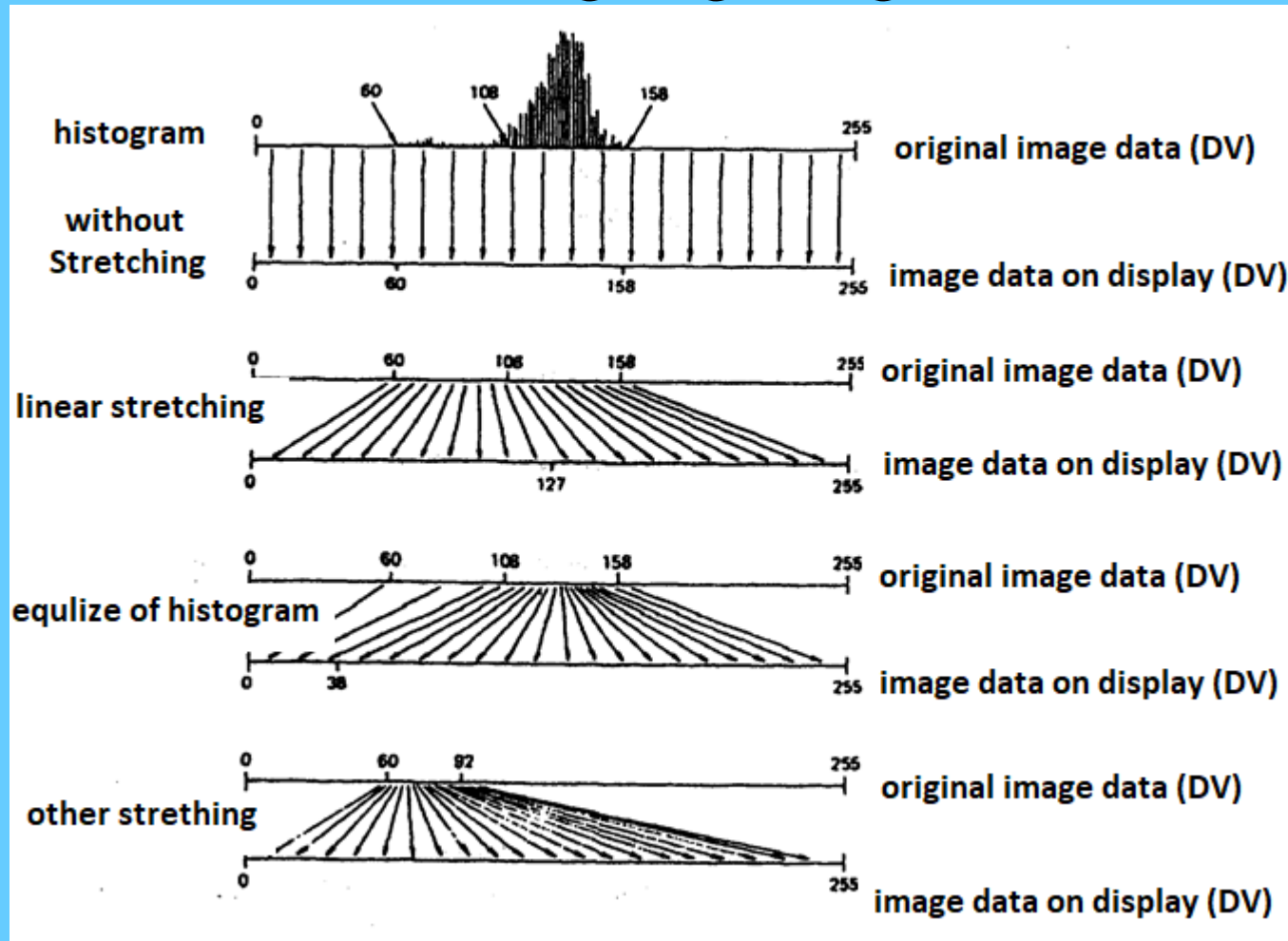



# RS data processing - digital image data RS

- Histogram- bar graph expressing the frequency of DV of the image file

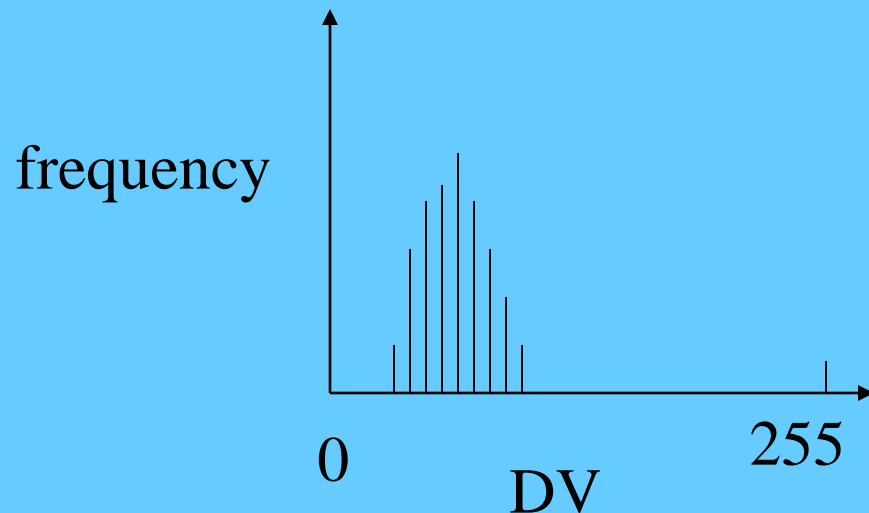

Histogram: frequency occurrence of DV in the image

# Digital Image Processing – Image Highlighting

- Data display by colour synthesis method - usually using 3 image components = three bands - each of them embedded in one of the colour axes - R, G, B
  - An image is created in :
    - The actual colors of the colors in the picture match the reality
    - False colour

# Digital Image Processing – Image Highlighting

## 2. Image filtering

- a method of local highlighting, i.e. highlighting that is performed sequentially for each value of the image file based on its DV and DV pixels in its surroundings
- The environment is defined by a submatrix - **kernel** = moving window (moving window)

# Digital Image Processing – Image Highlighting

- Kernel:

different types

1	1	1
1	2	1
1	1	1

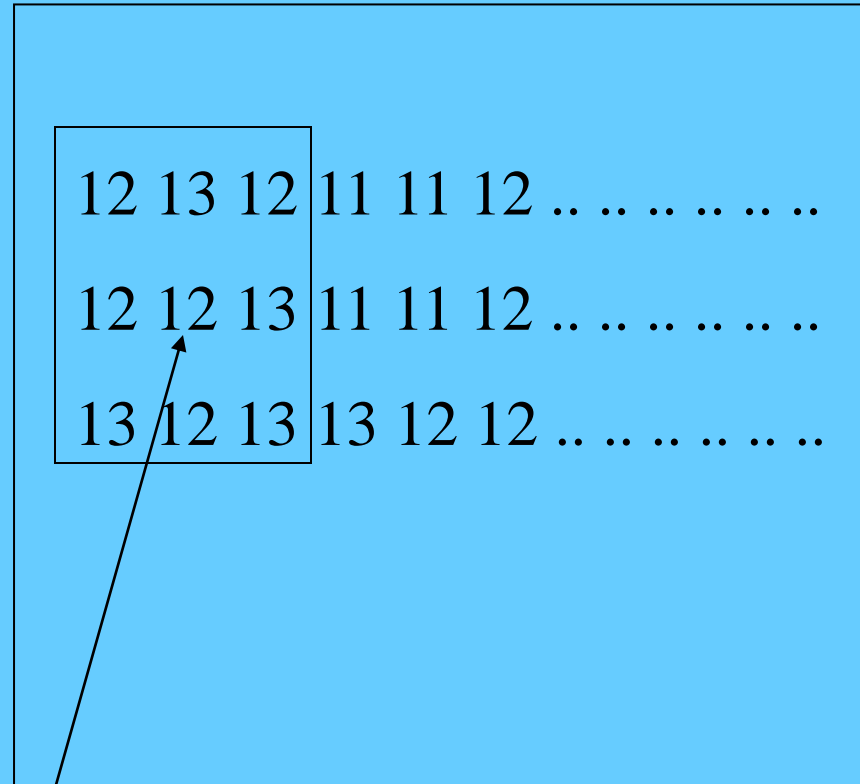

$$(1 \cdot 12 + 1 \cdot 13 + \dots) \cdot 1/9 = NV \text{ (new value)}$$

# Digital Image Processing – Image Highlighting

- Purpose of filtration:
  - Suppress small differences between DV - and highlight large differences - high-pass filters - highlight edges and lines
  - Smooth image - low pass filters - average (all values in kernel = 1)

# Digital Image Processing – Edge Highlighting

- **An edge in a grayscale image** is called a discontinuity in the image function, or an area in the image where the grayscale value changes significantly or in steps. Edges are an important component of an image and are often the information sought.
- The edges can be divided into 3 types:
  - - **roof edge** is a lighter linear formation on a darker background, e.g. dirt road, concrete road,
  - - **a ditch edge** is a darker linear formation on a lighter background, e.g. a watercourse,
  - - **a step edge** is an interface between a lighter and a darker object, e.g. field-forest interface, boundary between cultures.

# Digital Image Processing – Edge Highlighting

- Edge operator

The normal edge operator calculates the average from the differences in the image window and fits it behind the center pixel. In homogeneous regions the differentials will be zero, non-zero numbers will indicate the degree of probable presence of an edge.

Prewitt operator (also Sobel, Laplace-sharpening, Robinson, gradient, etc.)

$$p(i, j) = \frac{1}{8} \sum_{k=1}^3 \sum_{l=1}^3 |f(i, j) - f(k, l)|$$

$$dx(i, j) = |f(i+1, j-1) + f(i+1, j) + f(i+1, j+1) - f(i-1, j-1) - f(i-1, j) - f(i-1, j+1)|$$

$$dy(i, j) = |f(i-1, j+1) + f(i, j+1) + f(i+1, j+1) - f(i-1, j-1) - f(i, j-1) - f(i+1, j-1)|$$

for x direction

-1	-1	-1
0	0	0
1	1	1

for y direction

-1	0	1
-1	0	1
-1	0	1

# Digital Image Processing –

## Image Highlighting

### 3) **Vegetation indices**

- characterize the increase in reflectance between the R and IR bands - the most commonly used - **NDVI (normalized vegetation index)** (newly calculated channel):

$$\text{NDVI} = (\text{IR} - \text{R}) / (\text{IR} + \text{R})$$

where IR is near-infrared, R is red;

**Vegetation indices indicate the presence (quantity) and quality of green matter**



# Digital Image Processing - Classification

- Method where each pixel is assigned to a **class** (set of internal parameters)
- **Classification rules** need to be established - depending on radiation values on species and state parameters
- **Signature** = property that distinguishes the class from other surfaces - can be contained in one or more bands

# Digital Image Processing - Classification

- **Signature space** = image data components (= channels) used to build a classification rule

Types of signatures:

**spectral** - expressing the reflective or radiative properties of the surface under examination

**spatial** - they are determined by the spatial homogeneity of the object, which determines its boundary, or by the texture of the object

**temporal** - based on class changes over time

# Digital Image Processing - Classification

- Types of classifications:
- Classification:
  - pixel-by-pixel
    - controlled
    - uncontrolled
    - Hybrid
    - neural networks
  - other methods - textural classification

# Digital Image Processing - Classification

- Controlled classification:
  - Method where a part of the image data is selected - sample surfaces for individual classes = so-called **training sets**
  - **The training set** is composed **of the training surfaces of each class**
  - **The training set** should express the attributes, i.e. the properties that distinguish the classes from each other

# Digital Image Processing - Classification

- 3 types of classical classifiers

Classifier:

- **Minimum distances** - the pixel is assigned to the class to whose center of gravity its DV is closest
- **Parallelepiped** - the training set defines spatial parallelepipeds if a pixel has values such that it occurs in one - it is included in this class

# Digital Image Processing - Classification

- **Maximum likelihood classifier** -  
**maximum likelihood** (most used)
- variance, correlation and covariance are evaluated
- calculate the probability that the pixel value occurs within each class distribution,
- the pixels in the class training surfaces are assumed to have a normal distribution

# Digital Image Processing - Classification

- Maximum likelihood classifier

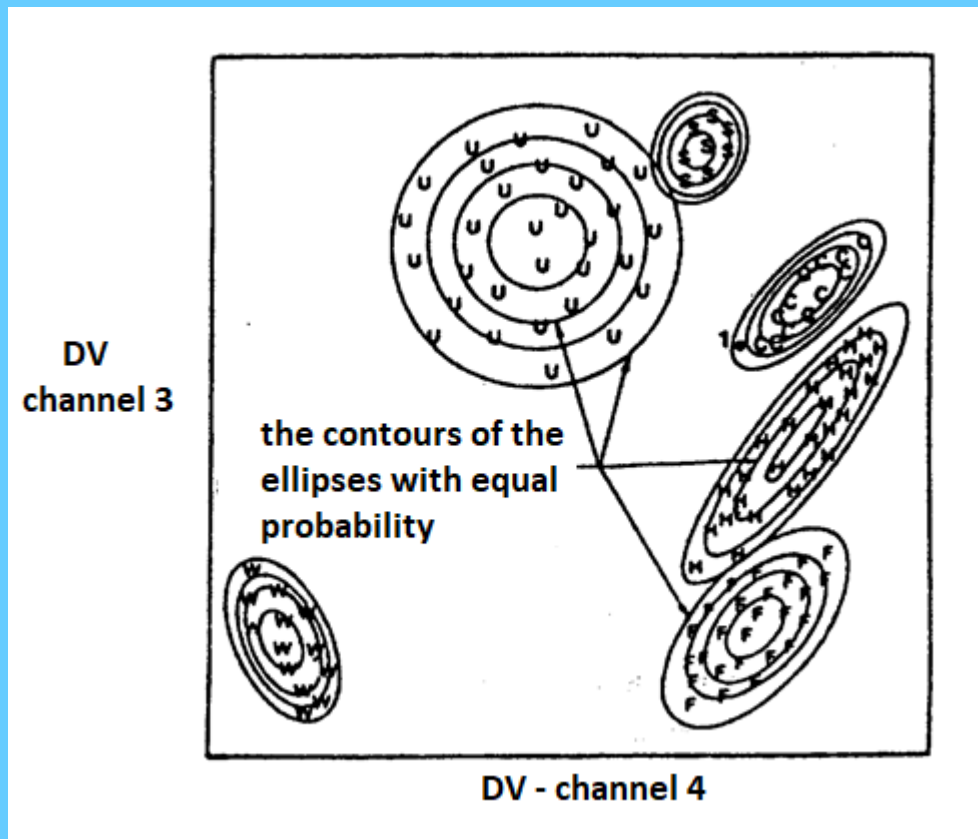

# Digital Image Processing - Classification

## Unsupervised classification

- Based on clustering the image according to DV in pixels using cluster analysis
- The result are clusters - classes that need to be given thematic content



# Digital image processing - unsupervised classification

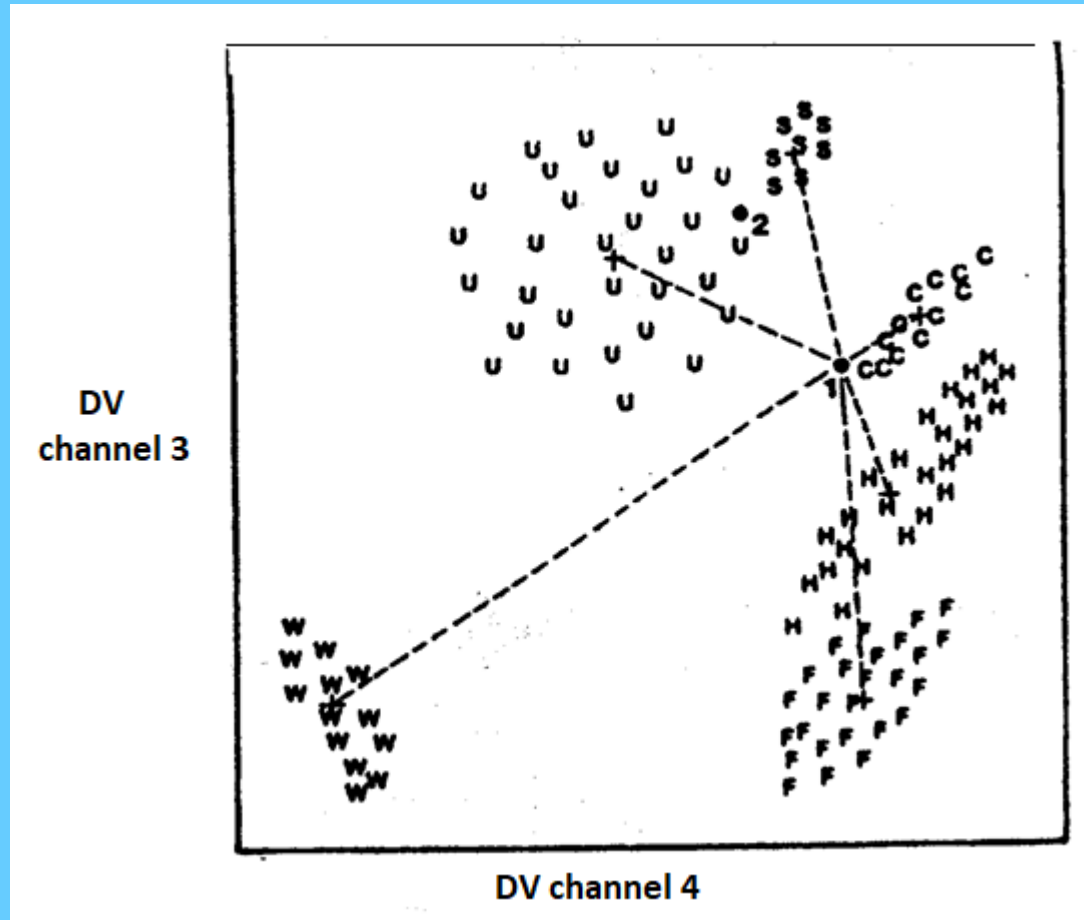

Clustering - accumulation of pixels with approximately the same properties

# Digital Image Processing - Classification

- The principle of cluster analysis:
  - Defining the approximate number of resulting clusters
  - Generate initial values (centroids = centres of gravity for clusters)
  - Assigning pixels to clusters to which their values are closest in multispectral space
  - Calculating the new centre of gravity for clusters
  - Repeat the previous 2 steps until all pixels are included
  - Determining the meaning of clusters
  - Determination of the resulting classes

# Digital Image Processing - Classification

- Unsupervised Classifiers:
  - **K-means** (K-average) - predefined number of clusters and number of iterations, initial position of cluster centers of gravity can be specified
  - pixel clustering - finding the smallest distance of a pixel to the clusters

# Digital Image Processing - Classification

- **ISODATA** - improved previous classifier
  - Cluster splitting may occur if the cluster heterogeneity (expressed as the standard deviation compared to a multiple of the initial value of the direction) is exceeded. deviation)
  - Two clusters can be merged if the distance between the centers of gravity is less than a predefined value
  - One cluster can be deleted and pixels can be sorted into other clusters if its pixel count is less than the specified value

# Digital Image Processing - Classification

Once the classification is created - the **accuracy of the classification** must be assessed:

- for the whole image set - unrealistic - exceptionally for experimental measurements
- For **test areas** - areas that have not been used for training areas

# Digital image processing - post-classification adjustments

Editing the resulting image file - usually removing unclassified pixels - by filtering - pay attention to the filters used:

Majority filter - an unclassified pixel gets a new value as the value of the pixel that occurs most often in the kernel

# Satellite systems and RS application areas

# Satellite systems

- Meteorological satellites - the oldest in the early 1960s
  - on geostationary orbits – 36,000 km
  - on the polar orbits - altitudes approx. 500-1000 km
- Satellite for RS:
  - special for RS
  - manned spaceflight
  - meteorological satellites



# Basic types of image data collection

- Passive - measurement of reflected or emitted radiation:
  - Analog, photographic (old-historical)
  - Phototelevision (old-historical)
  - Television (old-historical)
  - Scanning radiometers, digital cameras

# Basic types of image data collection

- Active - systems with their own sources of electromagnetic radiation emitted to the Earth's surface
  - radar imaging systems
  - lidars
  - altimetry
  - skaterometers

# Passive devices

- Analog, photographic equipment (historical, from 1960 till 1980 or nineties (Russia)
  - High spatial resolution (3 feets)
  - Radiometric quality problem - dependent on film quality
  - Panchromatic, colour and IR images - LFC, RMK A (USA), MSK-4, MK-4, KATE, KVR 1000, KFA 1000
  - Used in spy - Russia - satellites with Kosmos designation and orbital stations, USA – Corona system

# Passive devices

- Analogue TV systems (historical)
  - Right at the beginning in the 60s - low geom.resolution (3 km)
  - RBV (Return Beam Vidicon) cameras - also on Landsat 1,2 satellites - 3 bands - 185 x 185 km area, geom.resolution 79 m
  - 4 frame markers and 9x9 grid points
  - On Landsat 3 - 2 RBV Pan cameras - each 183 x 98 km with 13 km overlap

# Passive devices

- Television systems digital
  - Systems containing CCD (Coupled Charged Device) - recordings converted to analogue video signal and recorded on a video recorder or directly broadcast
  - If they are recorded directly in digital form, they are electronic scanners

# Passive devices

- Phototelevision systems
  - Used only for a short period of time - images were immediately developed and data was transported to Earth using a television camera and transmission technology

# Passive devices

- Scanning radiometers
  - Geostationary satellites - one orbit around the Earth in circular equatorial orbit = 1 day = the satellite is always in one place synchronously with the rotation of the Earth

Typical satellite representative from this group is **Meteosat (EU)**

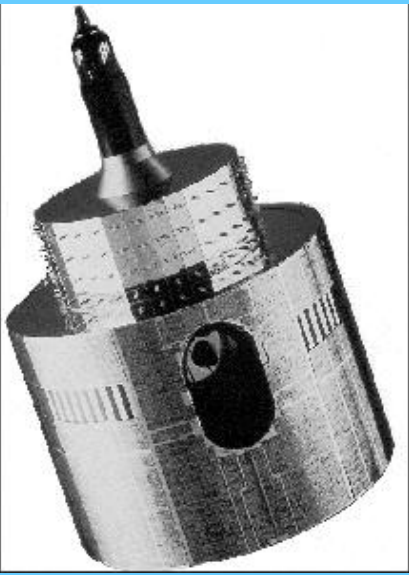

- Meteosat 1 (1977)- 3 bands - V+IR, thermal and water vapour absorption band - (5000x5000 pixels for one band, 2500x2500 pixels for two bands)
- Data measured by rotating the satellite around its axis (100 rpm) - 1 pixel is read in 6  $\mu$ s/12  $\mu$ s

# Passive instruments - Meteosat

- Recording time 25 minutes + 5 minutes (measurement)
- Dimensions:
  - Satellite diameter - 2.1m, height 3.2 m, weight 320 kg
- Bands
  - 0.5 - 0.9 m RS = 2.5 km
  - 5.7 - 7.1 m RS = 5.0 km water vapour zone
  - 10.5 - 12.5 m RS = 5 km - TIR



# Passive instruments - Meteosat

- Meteosat data products:
  - **Wind field** - CMW (Cloud motion winds) - map of average wind speed over the past 60 minutes - generated from 3 images 4 times a day
  - **Ocean temperature** - SST (Sea Surface Temperature) - radiation emitted from the surface at a wavelength of 11  $\mu$ m is proportional to the surface temperature after atmospheric correction - 2 times a day

# Passive instruments - Meteosat

- **Upper Tropospheric Humidity** UTH (Upper Tropospheric Humidity)
- **Convective Precipitation Index** - PI  
(Precipitation Index) is an estimate of the sum of precipitation for a period of 5 days - the colder the upper cloud layer, the more likely it is that precipitation will occur from this cloud
- **Cloud Analysis** - CA (Cloud Analysis) -  
compiled 4 times a day for up to 3 cloud types

# Passive instruments - Meteosat

- **Cloud Top Height** - CTH (Cloud Top Height) - is generated from the TIR - for a 1500 m step in a 3 - 12 km layer
- **Supporting data** - CDS (Climate Data Set) contains data from histogram analyses, shows IR band correction values - generated 8 times a day

# Passive instruments - Meteosat

## – Calculation of albedo

- $A = 0.0041 \cdot V / \cos \theta$ ,
  - where  $V$  is the pixel value in the visible band
  - $A$  albedo
  - $\theta$  - zenith angle of the Sun

## – Calculation of radiation temperature

- $R = (IR - IRSPC) \cdot IRCAL$ 
  - $R$  is the radiation temperature
  - $IR$  pixel value in the IR band
  - $IRSPC$ ,  $IRCAL$  - calibration constants (internet)

# Passive instruments - Meteosat

- Using
  - short-term weather forecasts (synoptic meteorology) - ocean surface temperature, water vapour content, rainfall, cloud parameters
  - warning systems for extreme meteorological and hydrological events

-

# Passive instruments - Meteosat

- Data received in the same geometric form - azimuthal projection in normal position at geostationary orbit distance - single unbiased pixel in nadir

# Passive instruments – geostationary satellites

Other examples of satellites:

- USA - GOES, GOES West, GOES East, G.Next
- ESA - METEOSAT, MOP
- Japan - GMS
- Russia - GMS,
- Japan- INSAT
- China - Fengyun

# Passive instruments – meteorological polar satellites



typical representative : (Tiros – N) NOAA

satellites, first 1978, now operated NOAA 20

Altitude 833 km, orbit time 102 minutes, 14  
orbits per day

Multispectral radiometer AVHRR mechanical-  
optical, 2400 km coverage - one area  
measured 2 times in 24 with the same scanner



# Passive instruments - polar-orbiting meteorological satellites - NOAA

Bands - RS 1.1 km

V 0.55 - 0.68 m

IR 0.725 - 1.1 m

TIR 3.55 - 3.92 m

TIR 10.50 - 11.30 m

TIR 11.50 - 12.50

# Passive instruments - polar-orbiting meteorological satellites - NOAA

## Usage:

for meteorological applications - cloud  
cover determination - V and IR

for environmental applications -  
determination of NDVI - amount of green  
vegetation - generated in 10 days -  
(maximum, assuming no cloud cover at  
least once per day)

# Passive instruments - polar-orbiting meteorological satellites - NOAA

- Bands 3-5: upper cloud layer temperature detection, ocean surface temperature, volcanoes and activity mapping, mapping

# Passive instruments - polar-orbiting meteorological satellites - NOAA

- Additional equipment = TOVS (Tiros Operational Vertical Sounder) consisting of 3 instruments:
  - HIRS/2 - High Resolution IR Sounder 20 channels mechanical scanner RS 17.4 km - 2240 km wide
  - 1.-5.: -- temperature profiles, CO absorption<sub>2</sub>
  - 6.-7.: - clouds
  - 8.: - surface temperature
  - 9.: 9 - ozone
  - 10th - 12th: water vapour content, *cirrus* type clouds
  - 13th - 17th: - CO absorption temperature<sub>2</sub>
  - 18th - 20th: - cloud cover

# Passive instruments - polar-orbiting meteorological satellites - NOAA

- SSU (Stratospheric Sounding Unit) - step scanning IR spectrometer in the CO absorption band (15 m) for temperature determination at altitudes of 25 - 50 km, RS 147.3 km
- MSU (Microwave Sounding Unit) - 4 bands - temperature measurement - in absorption band O<sub>2</sub> (5.5 mm), RS 109 km
- Data transmitted digitally via HRPT (High Resolution Picture Transmission)
- Data transmitted by APT transmission - only 2 bands with RS 4 km

# Passive instruments - polar-orbiting meteorological satellites - NOAA

- Data encoded in 10 bits
- Data in the form of LAC (Local Area Coverage), GAC (Global Area Coverage - less detailed than LAC)
- From NOAA satellites - tracking global change,
- data available free of charge at the web

# Passive instruments – polar satellites

typical representative : Landsat (since 1971)

- Original name ERTS (Earth Resource Technology Satellite)
- Sun-synchronous orbit \_ altitude 915 km for Landsat 1, 2, 3 - periodicity of the same flyby 16 days, 705 km - Landsat 4 - periodicity 18 days



# Passive instruments - polar satellites - Landsat

- MSS (Multispectral Scanner)
  - 4 spectral bands, 185 km bandwidth, radiometric resolution 6 bits, RS 80 m
  - 4.: 0.5 - 0.6 m - green - for water objects, bottom shapes, snow cover range
  - 5.: 0.6 - 0.7 m - red - water objects, soil, roads, vegetation (together with IR)
  - 6.: 0.7 - 0.8 m - near IR - water differentiation, application with vegetation and geology
  - 7. 0.8 - 0.11 m - near IR as band 6



# Passive instruments - polar satellites - Landsat

- TM (Thematic Mapper) scanner - direct scanning
  - From Landsat 4 (1982) – geom. resolution 30 m, TIR 120 m
  - the most used sensor for RS till new millenium
    - 1.: 0.45 - 0.52 m - blue - low contrast, influence of atmospheric scattering - for coastal mapping, identification of anthropogenic formations -
    - 2.: 0.52 - 06 m - green - effect of atmospheric haze scattering - mapping of green vegetation
    - 3.: 0.63 - 0.69 m - red - course of roads, areas without vegetation and anthropogenic formations - together with IR distinguishing green vegetation
    - 4.: 0.76 - 0.90 m - near IR - for spectral vegetation indices

# Passive instruments - polar satellites - Landsat

- 5.: 1.55 - 1.75  $\mu\text{m}$  - Wet. IR - vegetation study, soil moisture - distinguishing snow cover from clouds
- 6.: 10.4 - 12.5  $\mu\text{m}$  - TIR - recording of thermal radiation - related to humidity - can detect thermal stress of plants, in built-up areas thermal pollution - used for qualitative evaluation - RS 120 m
- 7.: 2.08 - 2.35  $\mu\text{m}$  - important for geological applications - range of minerals and rocks - specific radiant properties - differentiation of vegetation more difficult

# Passive instruments - polar satellites -

## Landsat

- Landsat 6 - crashes
- No data delivered since spring 2003 - replaced by Terra /ASTER data

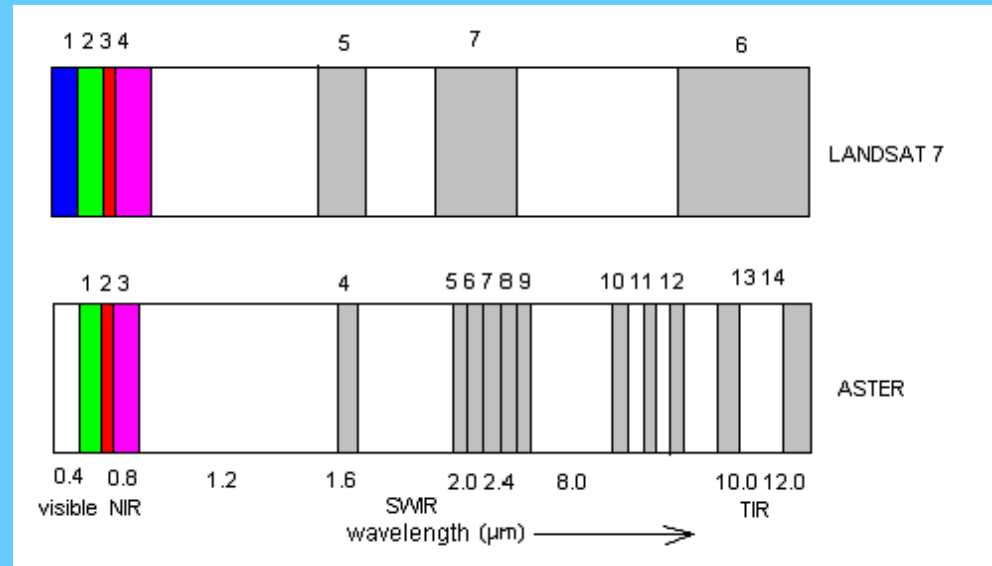

Landsat 7 - ETM+ Advanced TM, for band 6 - 60 m

Panchromatic band 15 m (2009),

Landsat 8 (2013),

Landsat 9 (2021)

# Landsat Missions: Imaging the Earth Since 1972

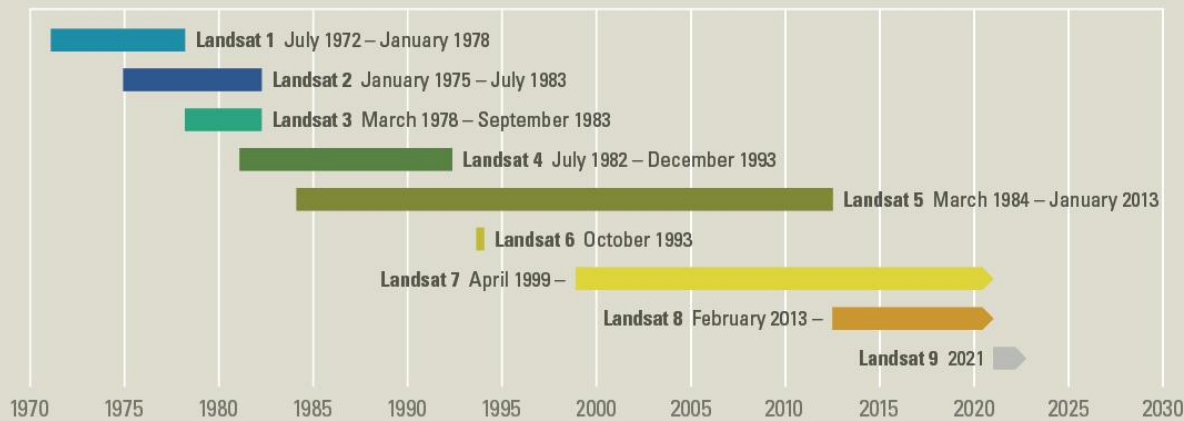

# Landsat 7, 8

- Band 1 Visible (0.43 - 0.45  $\mu\text{m}$ ) 30 m
- Band 2 Visible (0.450 - 0.51  $\mu\text{m}$ ) 30 m
- Band 3 Visible (0.53 - 0.59  $\mu\text{m}$ ) 30 m
- Band 4 Red (0.64 - 0.67  $\mu\text{m}$ ) 30 m
- Band 5 Near-Infrared (0.85 - 0.88  $\mu\text{m}$ ) 30 m
- Band 6 SWIR 1 (1.57 - 1.65  $\mu\text{m}$ ) 30 m
- Band 7 SWIR 2 (2.11 - 2.29  $\mu\text{m}$ ) 30 m
- Band 8 Panchromatic (PAN) (0.50 - 0.68  $\mu\text{m}$ ) 15 m
- Band 9 Cirrus (1.36 - 1.38  $\mu\text{m}$ ) 30 m





Landsat – data from 2012 free of charge, <https://earthexplorer.usgs.gov/>



EarthNow! Landsat Image Viewer

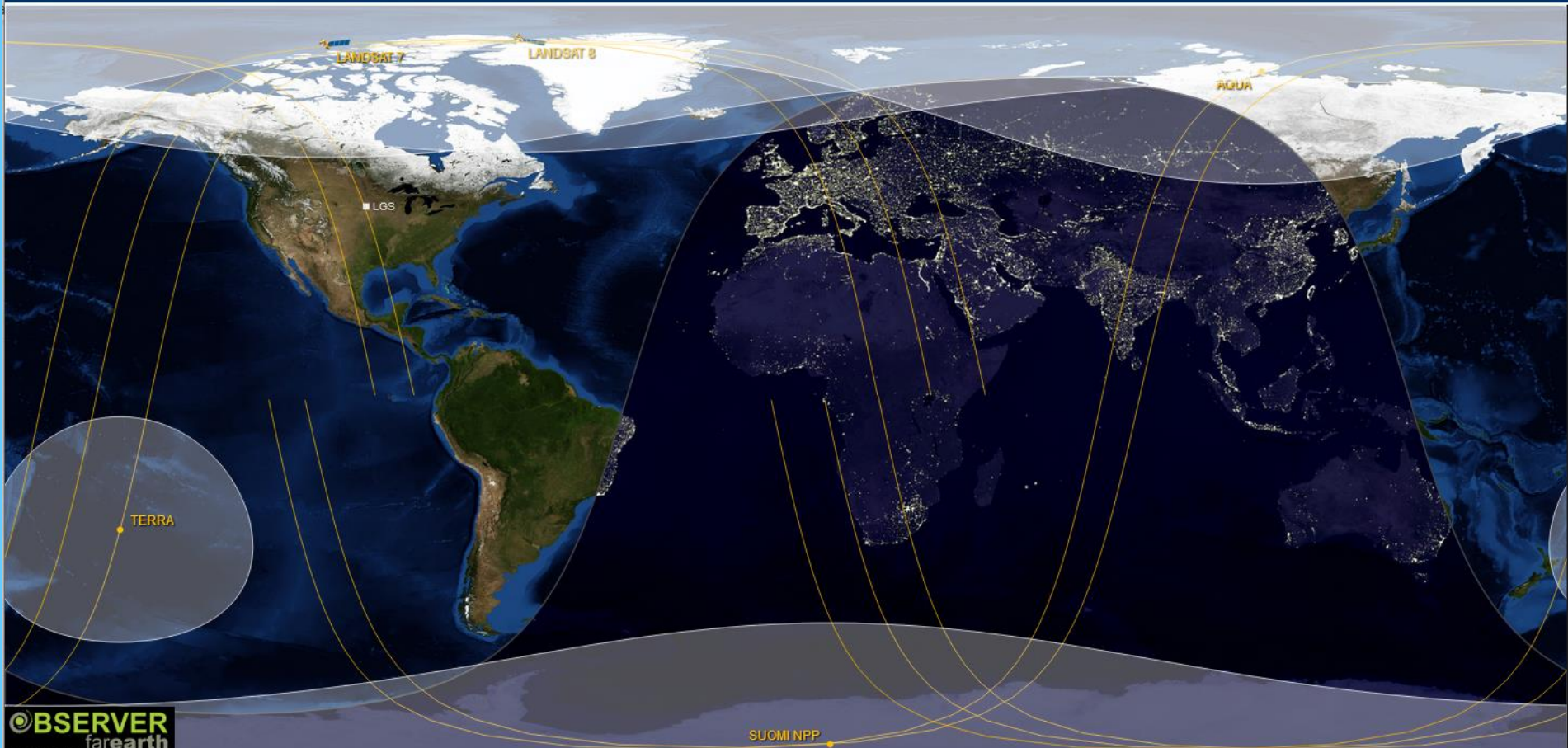

# Aster world DEM - GDEM



- The first version of the ASTER GDEM, released in June 2009, was generated using stereo-pair images collected by the ASTER instrument onboard Terra. ASTER GDEM coverage spans from 83 degrees north latitude to 83 degrees south, encompassing 99 percent of Earth's landmass.

- **The GDEM and ASTWBD are available for download from NASA Earthdata and Japan Space Systems.**

- The ASTER instrument provides the next generation in remote sensing imaging capabilities when compared to the older Landsat Thematic Mapper and Japan's JERS-1 OPS scanner. ASTER captures high spatial resolution data in 14 bands, from the visible to the thermal infrared wavelengths, and provides stereo viewing capability for digital elevation model creation

# Aster GDEM Global Digital Elevation Model

## Advanced Spaceborne Thermal Emission and Reflection Radiometer

30x30m

<https://lpdaac.usgs.gov/products/astgtmv003/#tools>

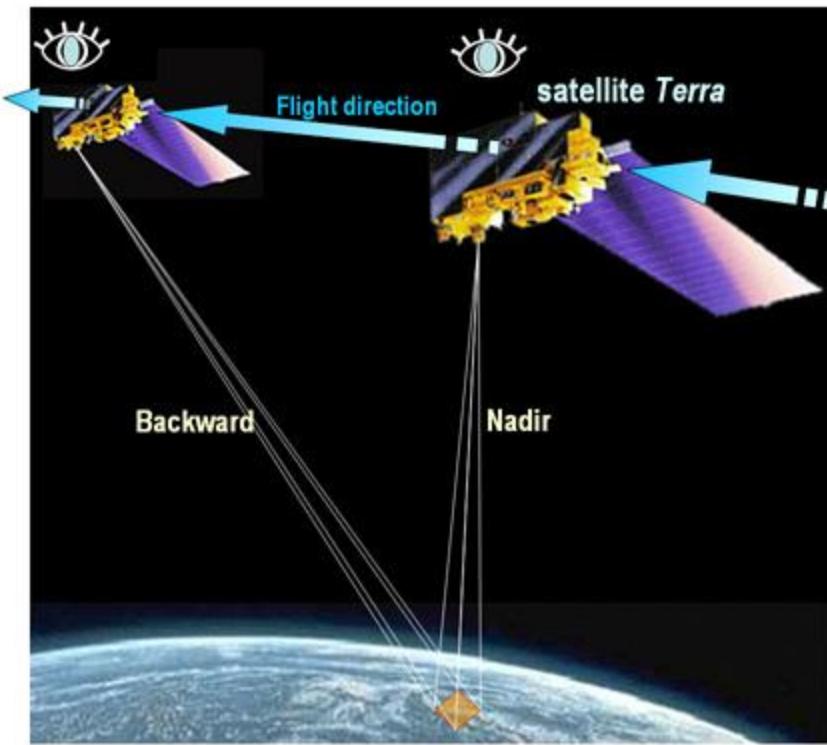

(A.) CORRECTED ASTER GDEM v2

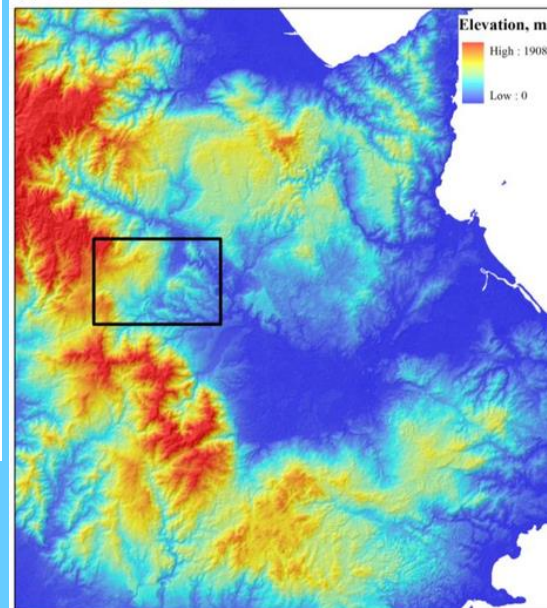

(B.) BEFORE ANOMALY DETECTION AND CORRECTION (SUBSET)

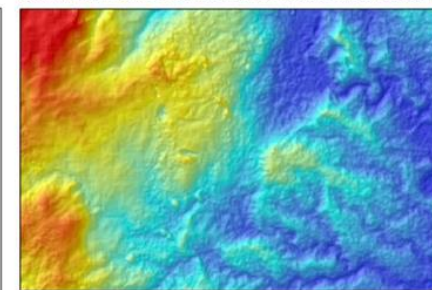

(C.) AFTER ANOMALY DETECTION AND CORRECTION (SUBSET)

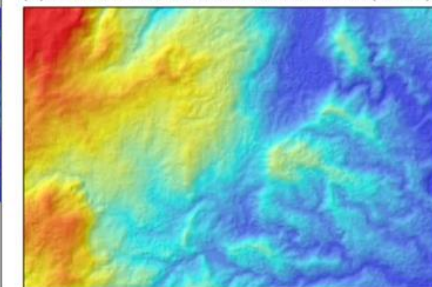

0 5 10 20 Km

0.05 1 2 3 4 5 Km



# Passive instruments - polar satellites - SPOT

1986 - SPOT 1, (1990 - SPOT 2, 1993 - SPOT 3,  
1998 - SPOT 4, 2002- SPOT 5, 2012-SPOT 6,  
2014 - SPOT 7

Time resolution - 26 days

Altitude 822 km, inclination  $98^\circ$

Electronic scanners

HRV (High Resolution Visible)





# Passive instruments - polar satellites - SPOT

- HRV - 2 multispectral scanners - longitudinal scanning - each scanning an area 60 km wide from the projection of the flight path - with an overlap of 3 km - 1 line 6000/3000 pixels - offset  $\pm 27^\circ$
- PAN mode - 0.51 - 0.75 m - RS 5x5 m (calculated from two with half overlap -RS =2.5m)
- XS (multispectral mode) - RS 20 x 20 m, 8 bits
  - 0.50 - 0.50 m - green -
  - 0.61 - 0.68 m - red
  - 0.79 - 0.89 m - near IR

# Passive instruments - polar satellites - SPOT

- Thanks to the tilt capability - possibility of DTM creation (from two orbits)
- Use : land use, differentiation of buildings, water areas, green vegetation
  - From XS data - colour synthesis data in false colours
  - Combination with PAN - increased spatial resolution (pan sharpening)

# Passive instruments - polar satellites - IRS

## Indian Remote Sensing Satellite IRS

- Since 1988 - IRS-1A, IRS-1B, IRS-1C, IRS-P2, IRS-P3
- Equipment - LISS-1, LISS-2, LISS II, WiFS, LISS III, Pan= RS 5.8 m
- IRS-1C - provides  $\pm 2.5^\circ$  deviation - stereoscopic pairs

# Passive instruments - polar satellites - spy

- CORONA satellite system - 1960 - 1972
  - Series of satellites in subpolar orbit with  $77^\circ$  inclination
  - Flight altitude 200 km - 800 km - flight duration 1 day to 16 days
  - Black and white photos, also colour and IR
  - RS 12 m to 2 m
  - Part of the USSR and Europe and Asia
  - Archive managed by USGS \_ internet

# Passive instruments - polar satellites - JERS-1

- Japanese satellite - radar + 2 optical sensors
  - OPS - 7 bands 0.52 - 2.40 m
- RS 18 x 24 m
- It is possible to take stereo-doubles in the direction of the flight path - deflection  $15.3^\circ$  before and after the nadir

# Sentinel (EU - ESA)

- Depending on the spectral band, they provide a spatial resolution of 10, 20 or 60 m. Thanks to the Sentinel 2A+2B satellite constellation, the temporal resolution is 5 days. Sentinel data are available at <https://scihub.copernicus.eu/>



- Comparison of agricultural land use in the Czech Republic and Austria in 2018.
- Source: Copernicus Programme (ESA), Sentinel-2 satellite data, own processing, 2019





Comparison of  
NO<sub>2</sub>  
concentrations over  
Europe during  
pandemic Covid-  
19. 16.3-18.4. 2019  
and 2020. Sentinel  
5P, Copernicus

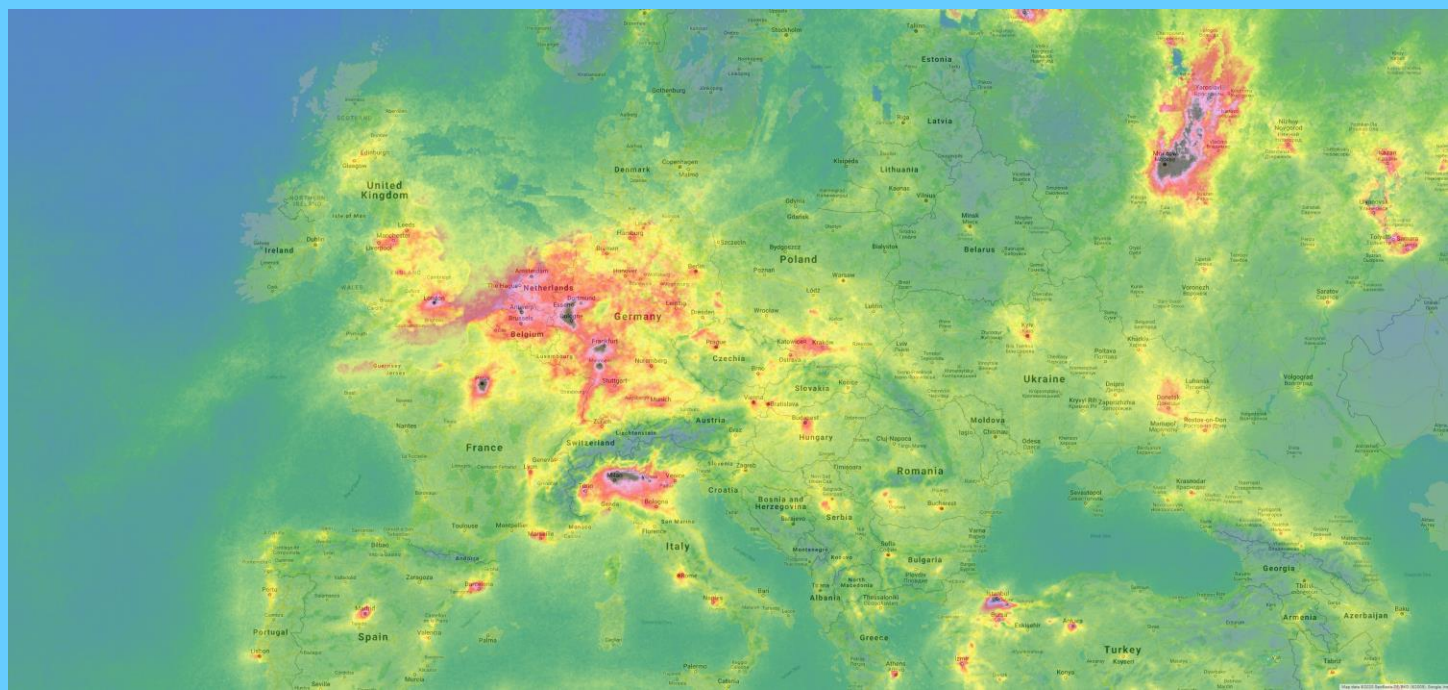



# Passive instruments –

Very High Resolution Satellite - VHR

-big boom after 2000; today dozens of satellites with submeter resolution, business as usual, private sector

- Very High Resolution (1 m or better, PAN)

1999: IKONOS - 3 VIS and 1 IR bands RS = 4m,  
1 PAN = 1m, 11 bits

2000: EROS - PAN 1.8 m

2001: QuickBird 3 V and 1 IR - RS =2.4m PAN=  
0.6 m

2008 : GeoEye, 0.5m ...etc.

# Passive instruments - Very High Resolution Satellite - VHR

- IKONOS 1 (1999)



WorldView – 3 (2014-till now)

WorldView – 4 (2016-2021)

Geom. resolution:

- PAN 31 cm,
- Multispectral 1.24 m





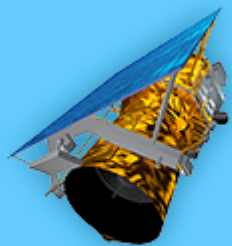

**GEOEYE-1** **SHD**  
(0.41m)

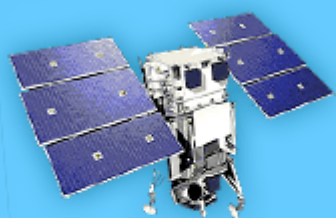

**WORLDVIEW-1** **SHD**  
(0.46m)

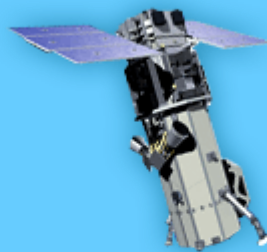

**WORLDVIEW-2** **SHD**  
(0.46m)

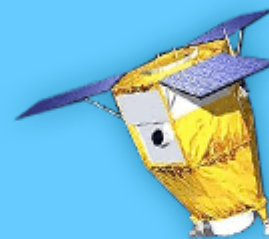

**PLEIADES-1A** **SHD**  
(0.5m)



**QUICKBIRD** **SHD**  
(0.61m)



**IKONOS** **SHD**  
(0.82m)

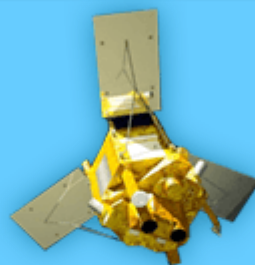

**SPOT-6** **HD**  
(1.5m)



**SPOT-5** **HD**  
(2.5m/5m)

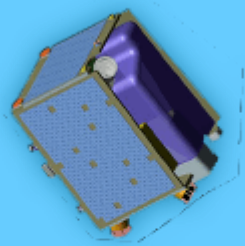

**RAPIDEYE** **HD**  
(5m)

# Passive instruments -

## Hyperspectral data

- up to hundreds of spectral bands

- 0.38 and 2.55  $\mu\text{m}$  can be divided into up to 217 intervals of 10 nanometres (0.01  $\mu\text{m}$ )
- detectors for VNIR (near IR) silicon microchips,
- Indium Antimony (InSb) for Short Wave InfraRed (SWIR, between 1.0 and 2.5  $\mu\text{m}$ )
- spectral reflectance curves can be plotted

# Hyperspectral imaging

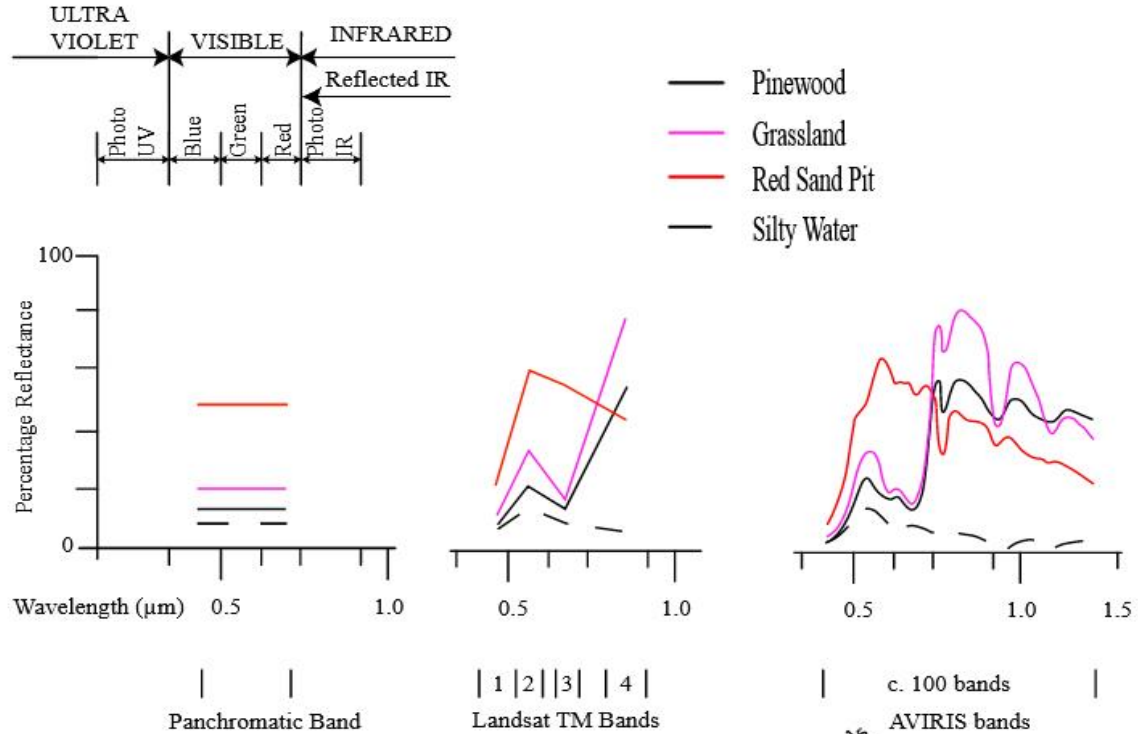

Panchromatic Band

Landsat TM Bands

AVIRIS bands

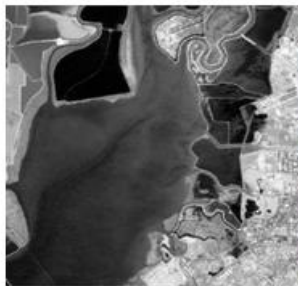

Single band



Multispectral

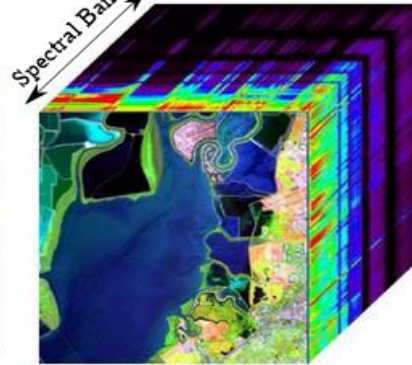

Hyperspectral



This work is licensed under a Creative Commons Attribution 3.0 Unported License.  
 Author: <http://commons.wikimedia.org/wiki/User:Arbeck>

# Passive instruments - Hyperspectral data

**JPL**

## AVIRIS CONCEPT

EACH SPATIAL ELEMENT HAS A CONTINUOUS SPECTRUM THAT IS USED TO ANALYZE THE SURFACE AND ATMOSPHERE

224 SPECTRAL IMAGES TAKEN SIMULTANEOUSLY

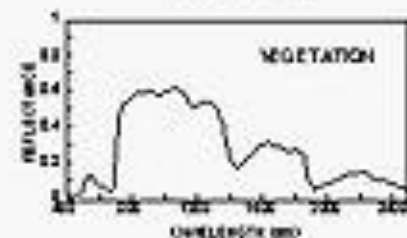
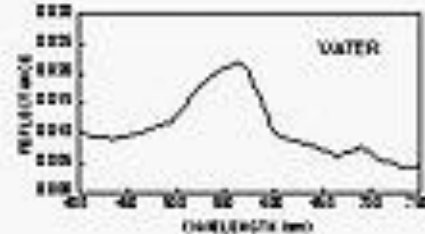
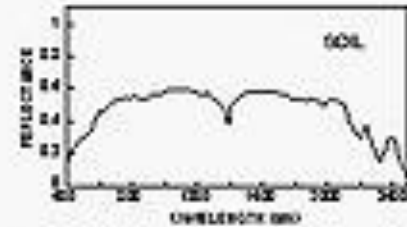
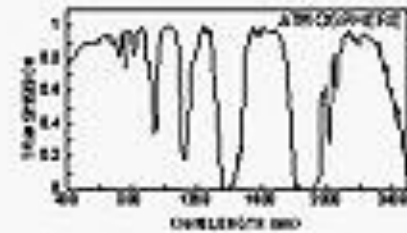
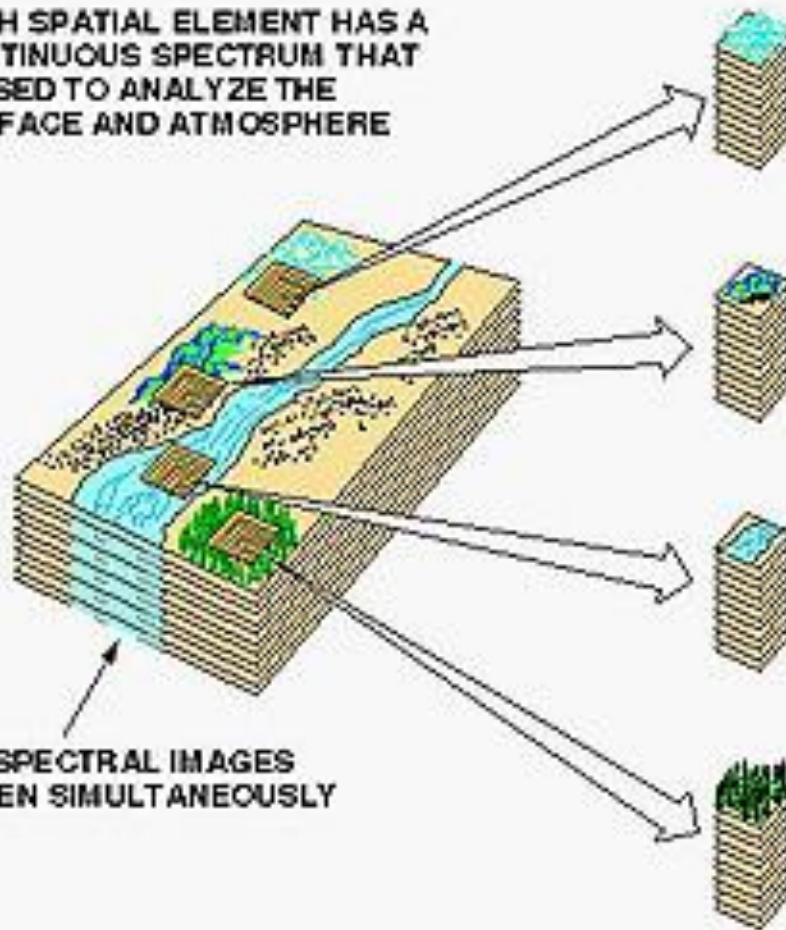

# Passive instruments - Hyperspectral data

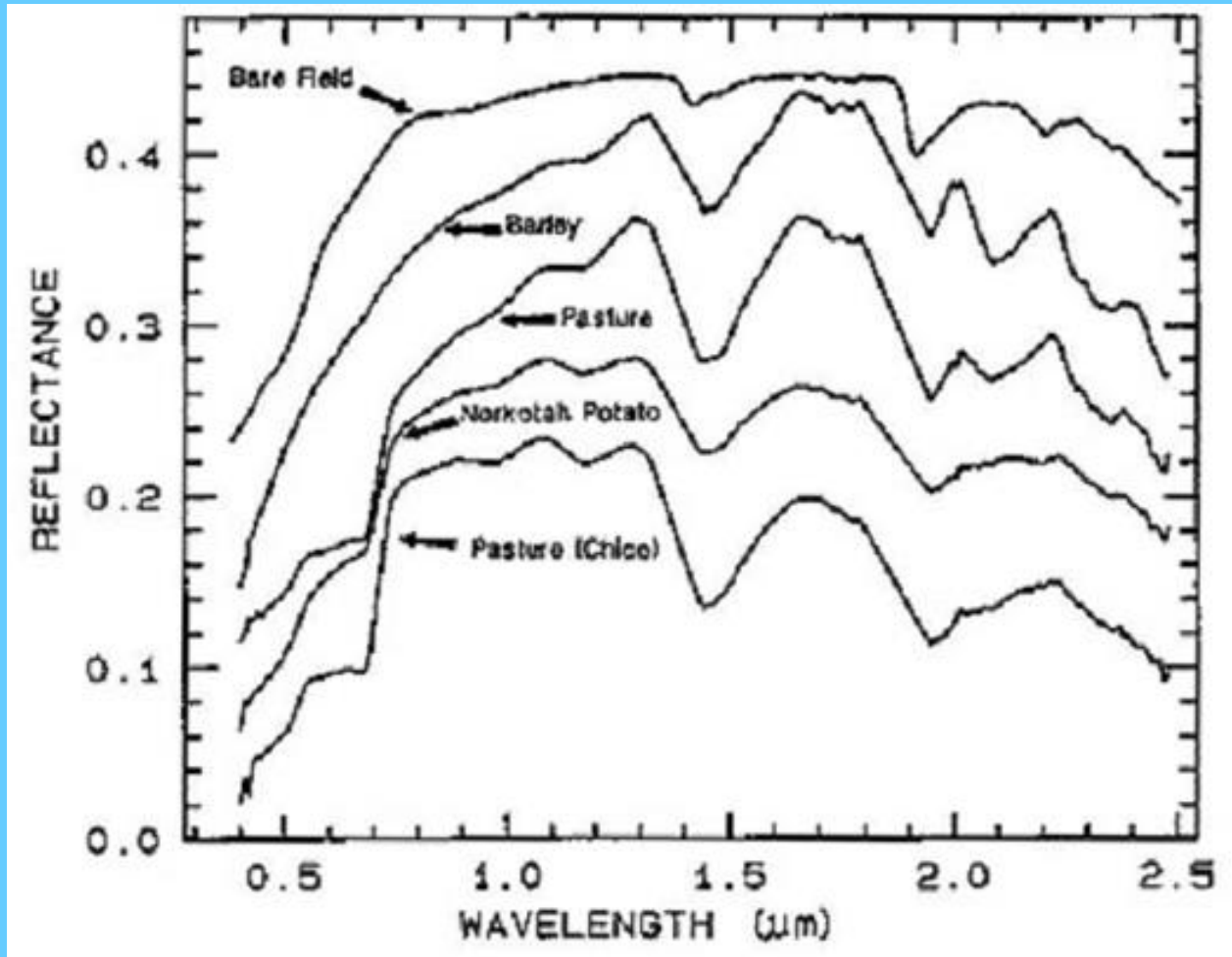



# Passive instruments - Hyperspectral data

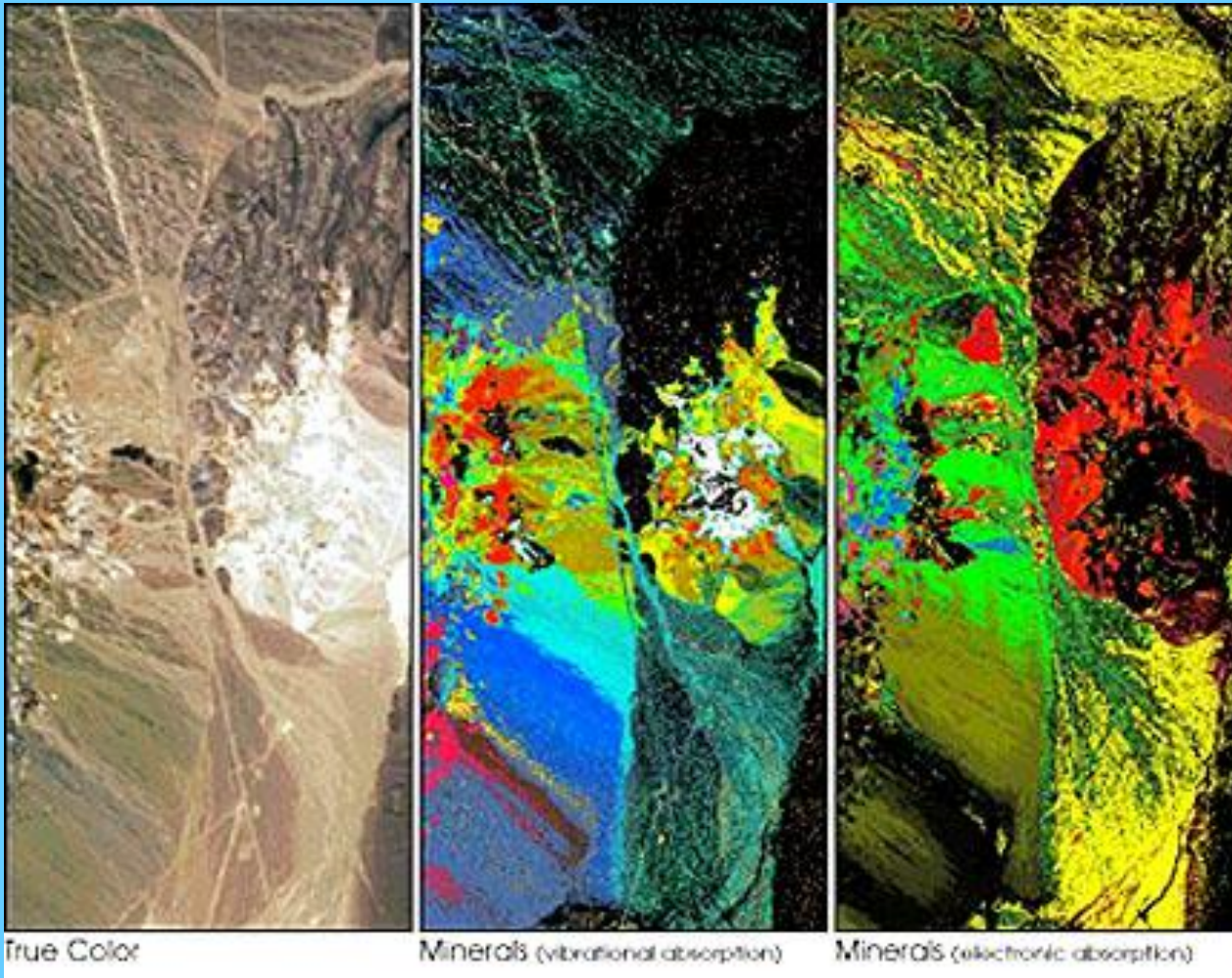

# Active instruments - radars

- Active RS - radar is a source and receiver at the same time
- Measurements in the MW area
- It passes through clouds, fog, darkness
- MW is sensitive to surface roughness and humidity:
  - Higher humidity, higher roughness and substances with high dielectric constant have high reflektivitiy
- Unlike the optical imagery, this iamging radar works at night and is not affected by cloud cover. The processing is not easy and different from optical sensors, it depend on special softwares and modules.

# Active instruments - radars - measurement

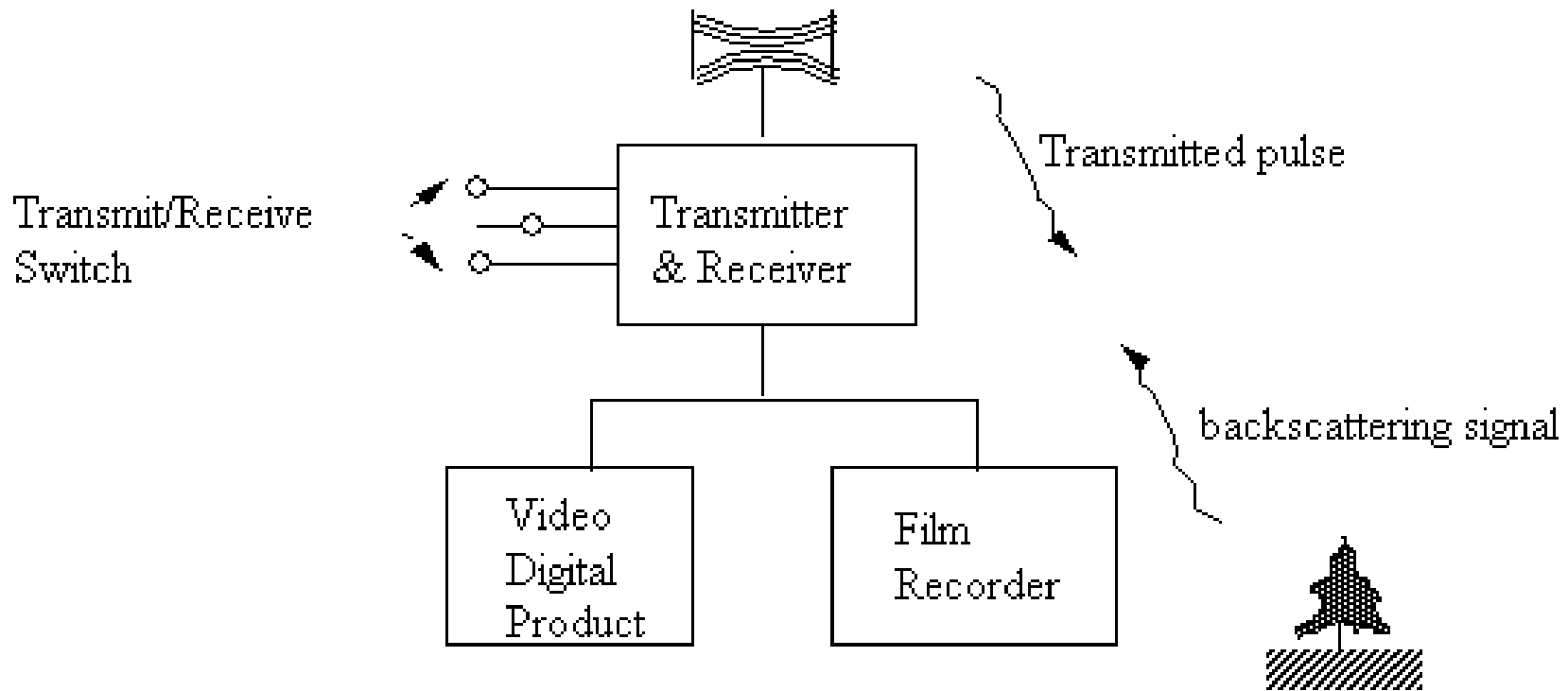

# Active instruments - radars - measurement

Measurements in  
oblique direction  
depending on  
time

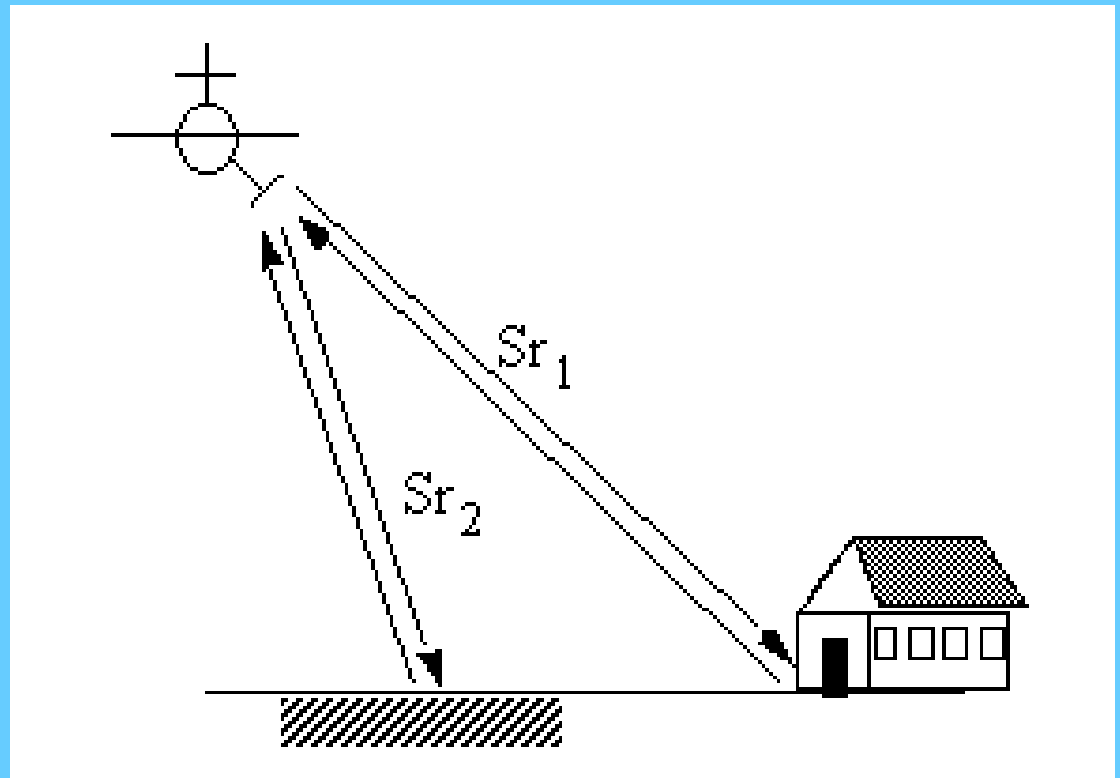

# Active instruments - radars - measurement

→  $r_g$  resolution on Earth - depends on oblique resolution and angle of incidence

↘  $r_s$  resolution in oblique direction

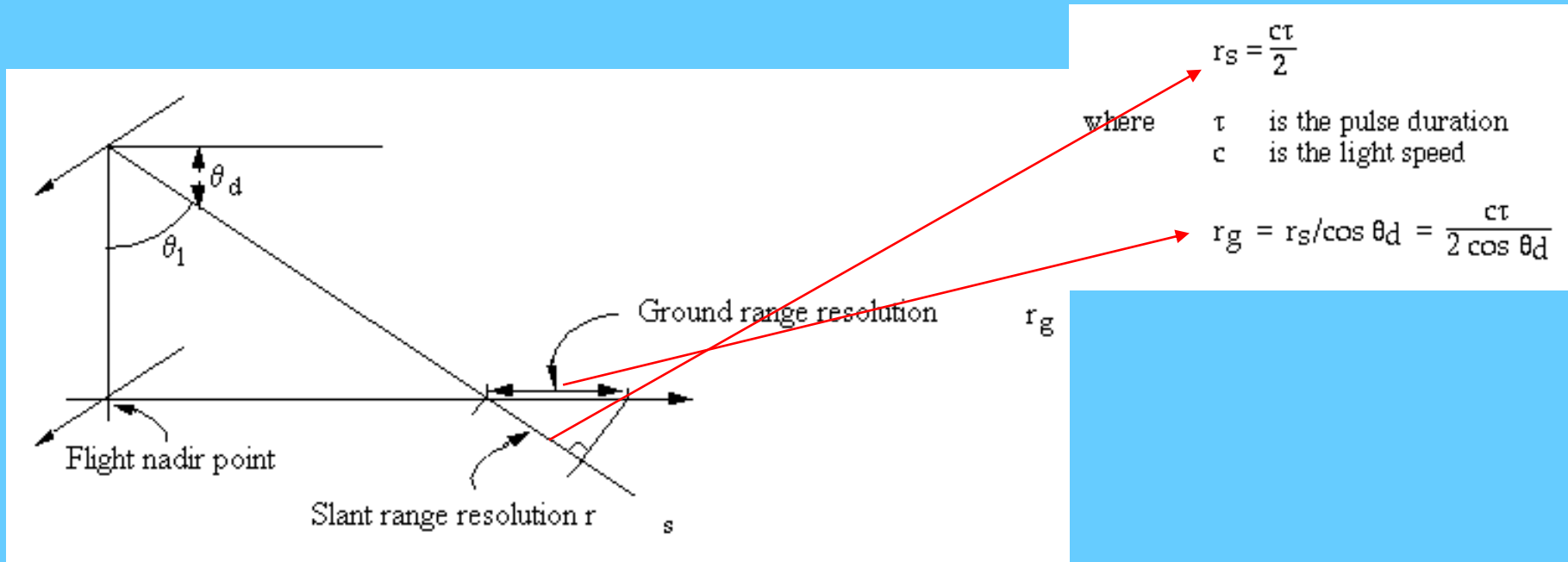

# Active instruments - radars - measurement

- Oblique measurement and its impact on the size of objects at different distances from the flight projection

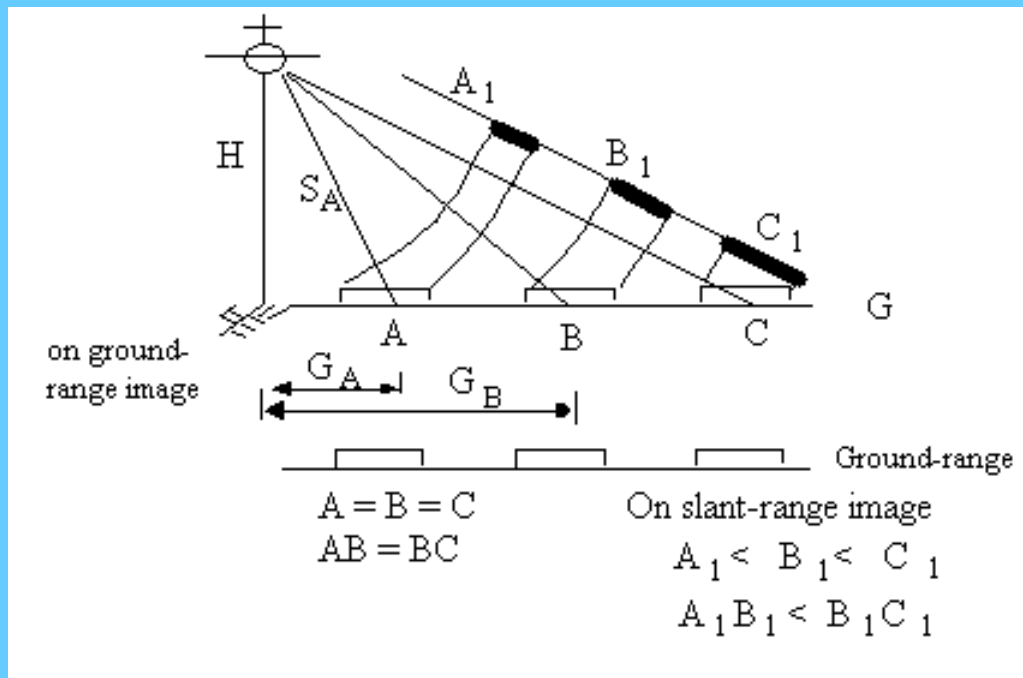

# Active instruments - radars - measurement

- Flipping an object in the image

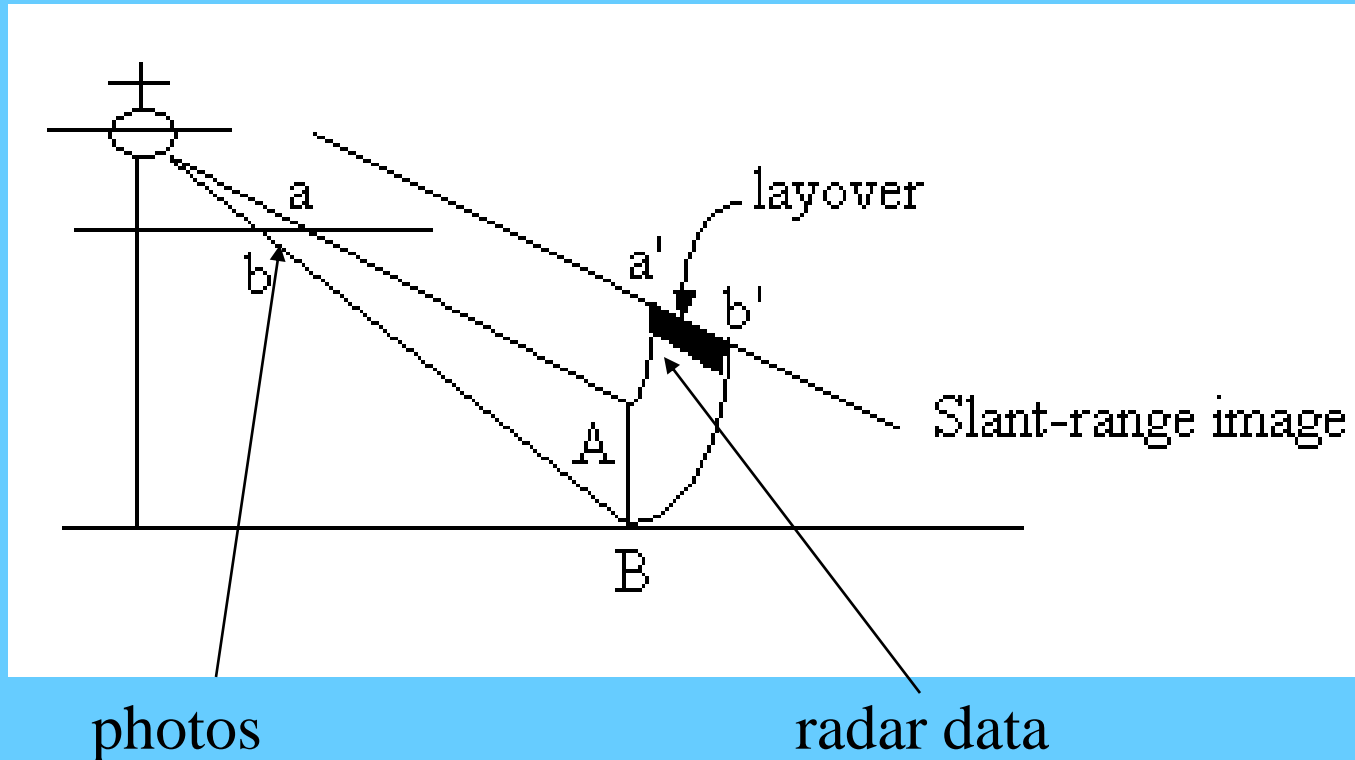

# Active instruments - radars - measurement

- The problem of terrain disparity

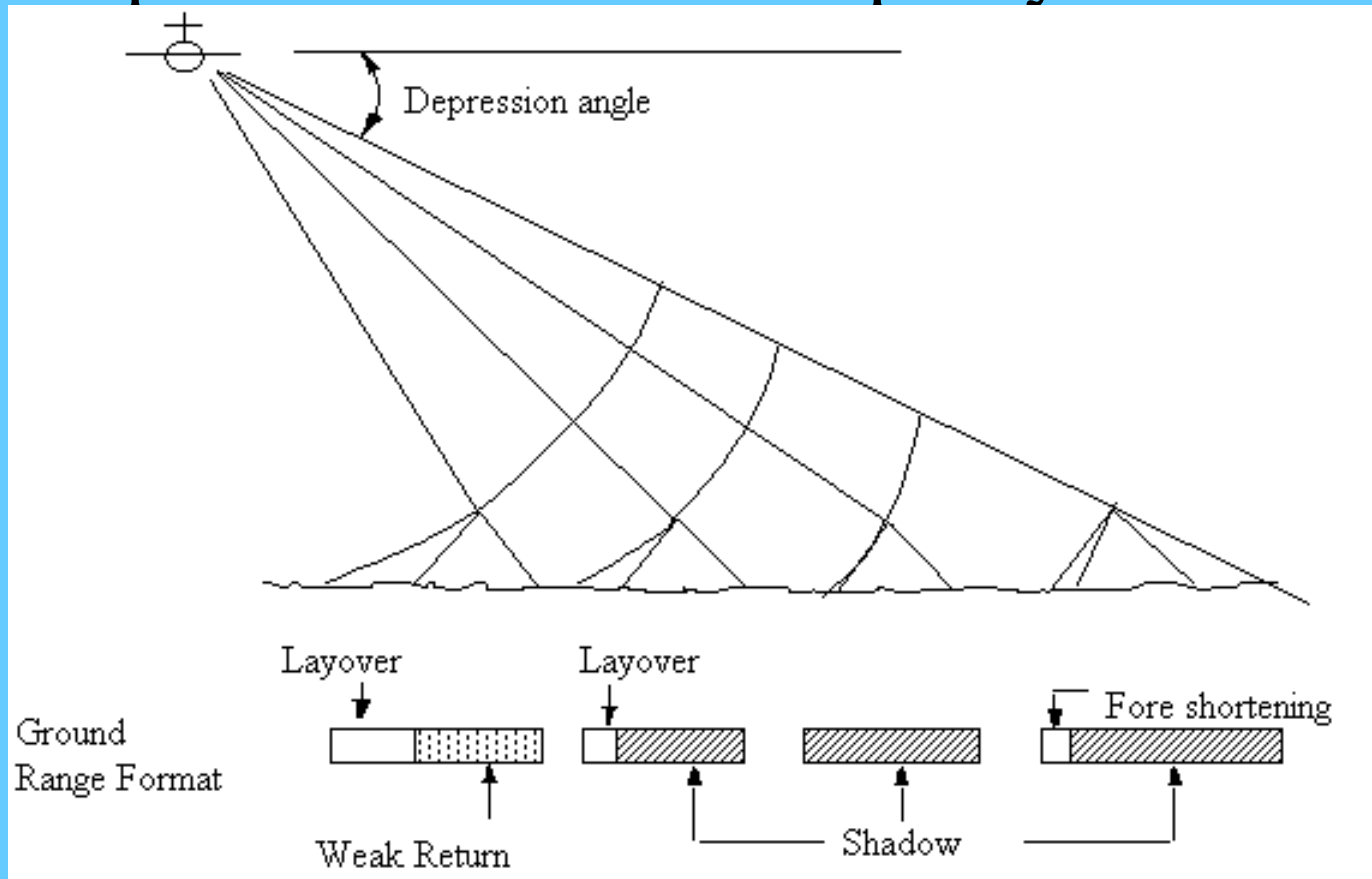



# Active instruments - radars - measurement

- Layover - overlap - the sum of signals from the area in front of the terrain roughness and part of the elevated area = large reflection
- Weak return - small bounce from the reverse side of a terrain irregularity
- Shadow - areas from where there is no reflection , are hidden
- Forshortening - backscatter densification - large reflection from a large area in a short time - in a small area of the image

# Active instruments - radars

- Types of radars by antenna:
- with actual aperture - RAR - azimuth resolution - determined by the ratio of the wavelength and the actual length of the antenna  $\beta = \frac{\lambda}{\alpha}$
- With synthetic aperture - SAR - azimuth resolution is adjusted by applying the Doppler principle

# Radar data - radars

## (Space-borne radars) satellite radars

First SeaSat launched in 1978, L-band radar, swath width 100 km, polarization HH, ground resolution 25 m x 25 m

- Shuttle Imaging Radar, SIR-A, SIR-B, SIR-C
- The European Space Agency(ESA) 1991: ERS - 1, 1995 - ERS -2, 2002 - ENVISAT
- 1992 Japanese JERS -1
- 1995 Radarsat (Canada)
- 2008 TerraSar X, 1m resolution
- COSMO-SKYMED
- SENTINEL

# InSAR Technology

Interferometric Synthetic Aperture Radar (InSAR)

Unique capabilities: Remote, high-density measurements with millimetric accuracy

[https://en.wikipedia.org/wiki/Interferometric\\_synthetic-aperture\\_radar](https://en.wikipedia.org/wiki/Interferometric_synthetic-aperture_radar)

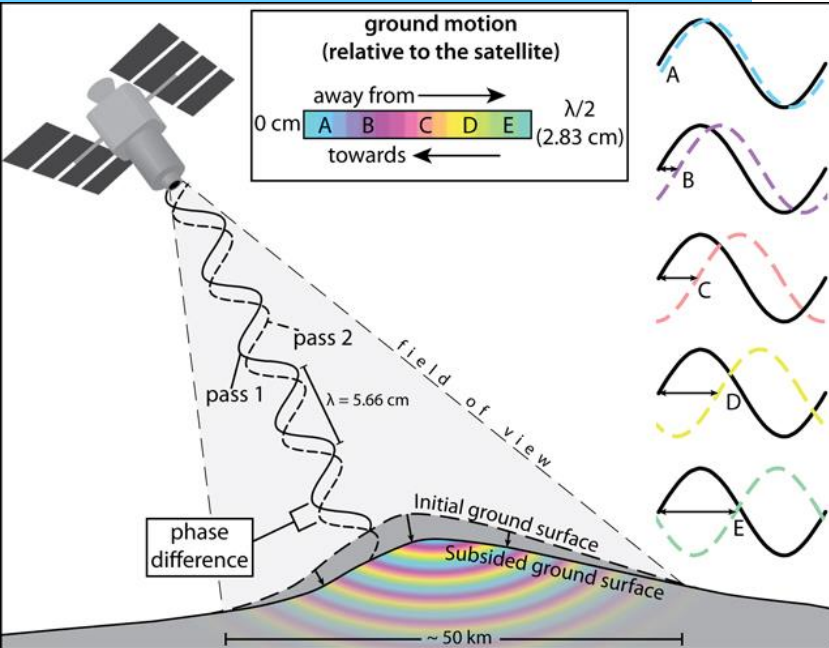
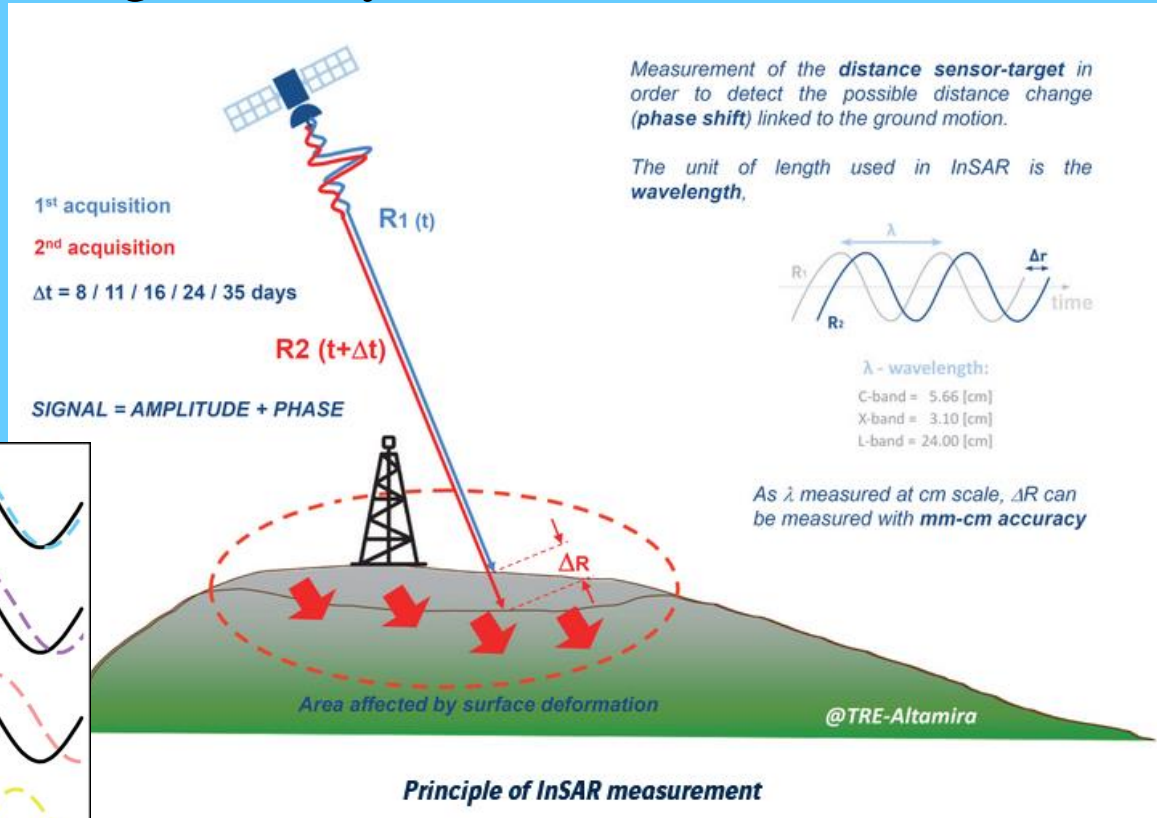

<https://www.geostockgroup.com/en/interferometric-synthetic-aperture-radar-insar-technology/>

<http://insar.space/insar-technology/>

See: <https://www.youtube.com/watch?v=MXixd1xkZh8>



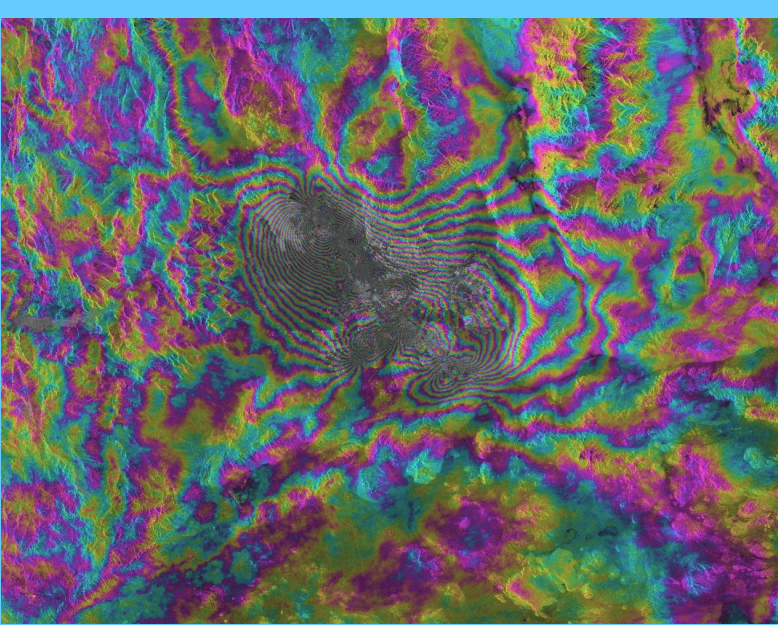

Radar sensors transmit electromagnetic waves of a certain frequency (GHz) in the microwave region (cm) and analyse the reflected signals. The SAR image is a combination of amplitude and phase information. The amplitude information depends on the sensor parameters and the physical properties of the target and defines the amount of energy backscattered by each pixel on the ground surface. Phase information is related to the signal path between the radar antenna and the target on the ground surface. The InSAR technique is based on measuring the phase and comparing image data from different sensor positions or from a time base.

Monitoring of Earthquakes



*Example of annual displacement over one mining activity site*

# Space shuttle radar topography mission (2000) (srtm DEM model)

- Free DEM from InSAR
- Version 1 (2003-2004) is almost the raw data.<sup>[8]</sup>
- Version 2.1 (~2005) is an edited version of v1. Artifacts are removed, but voids are not yet filled. There are 1-arcsecond data over the US.<sup>[9]</sup>
- Version 3 (2013), also known as SRTM Plus, is void-filled with ASTER GDEM and USGS GMTED2010. This release is available in global 1-arcsecond (30 meter) resolution since 2014.

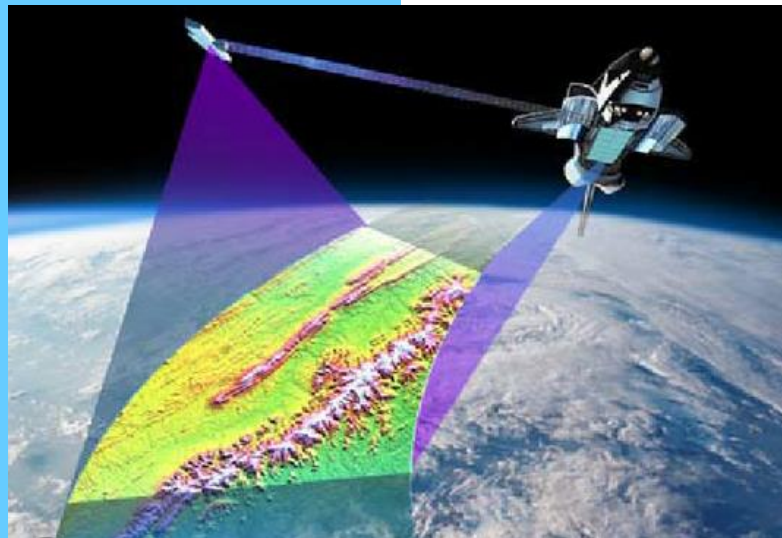
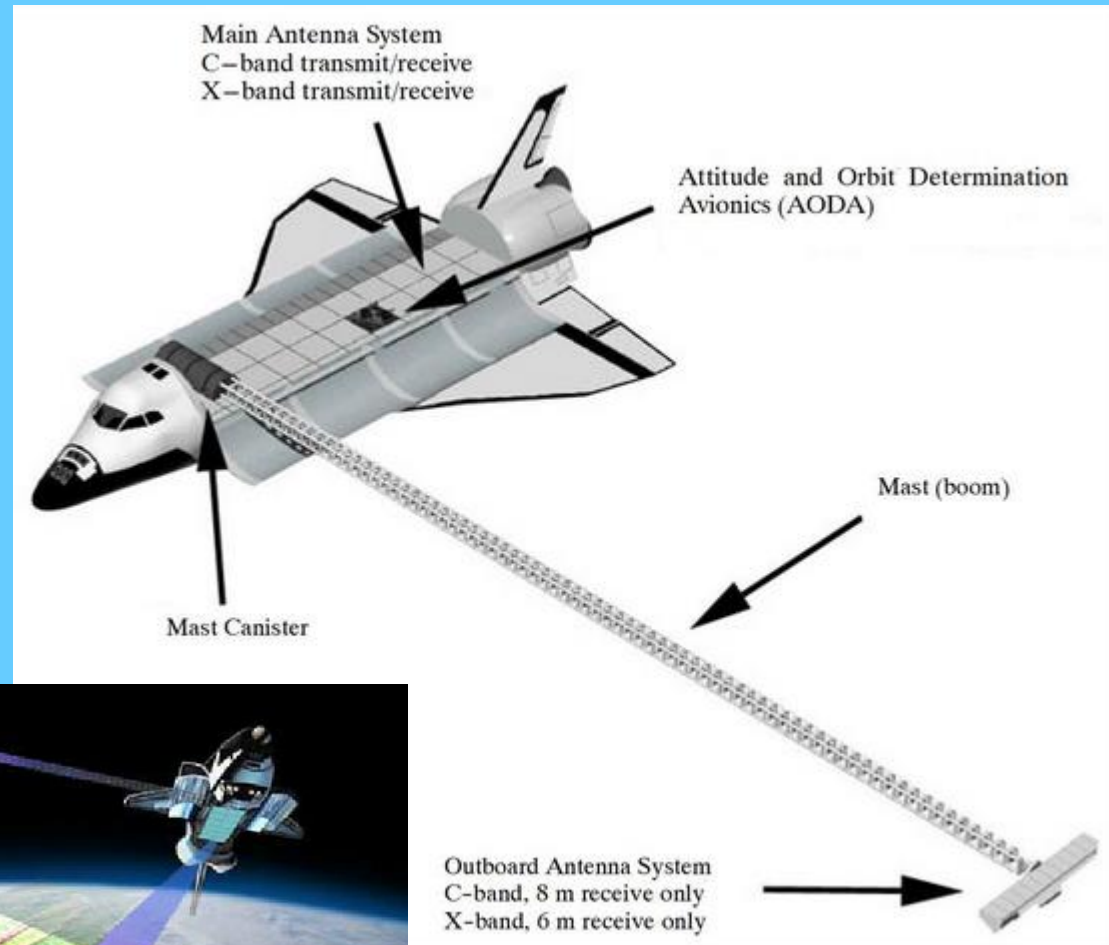

<https://www2.jpl.nasa.gov/srtm/dataproduct.htm>



# Shuttle Radar Topography Mission

- In February 2000, the Endeavour rocket mission was carried out, on which a special radar sensing apparatus was deployed to acquire interferometric radar data from virtually all over the world in 11 days.
- (30 m x 30 m), 16 m absolute vertical accuracy and 20 m absolute horizontal accuracy

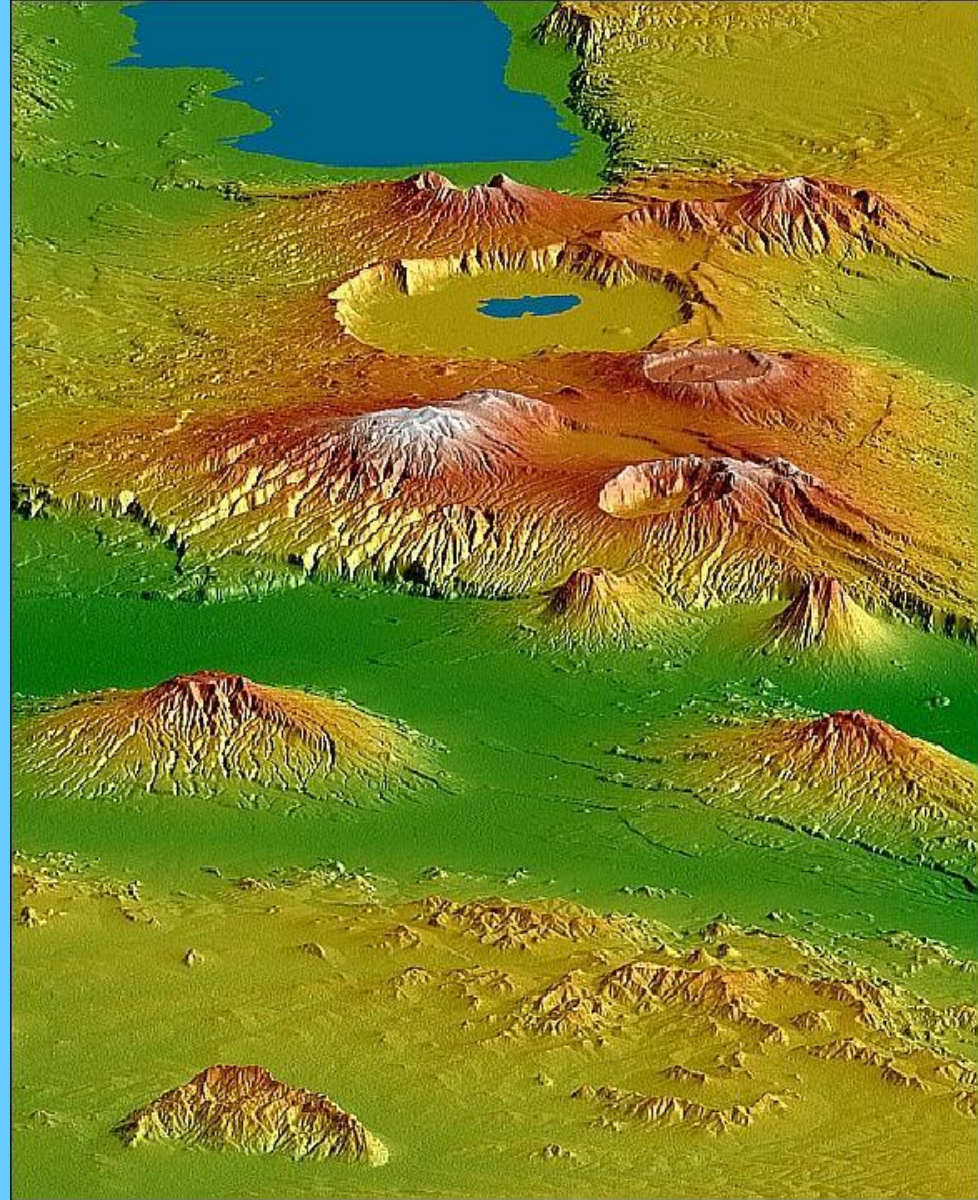

SRTM DEM (Digital Elevation Model) Tanzania (NASA/JPL)

# Radar data

- Death Valley  
Seasat  
L-band radar  
white spaces =  
*forshortening* or  
*overlay*

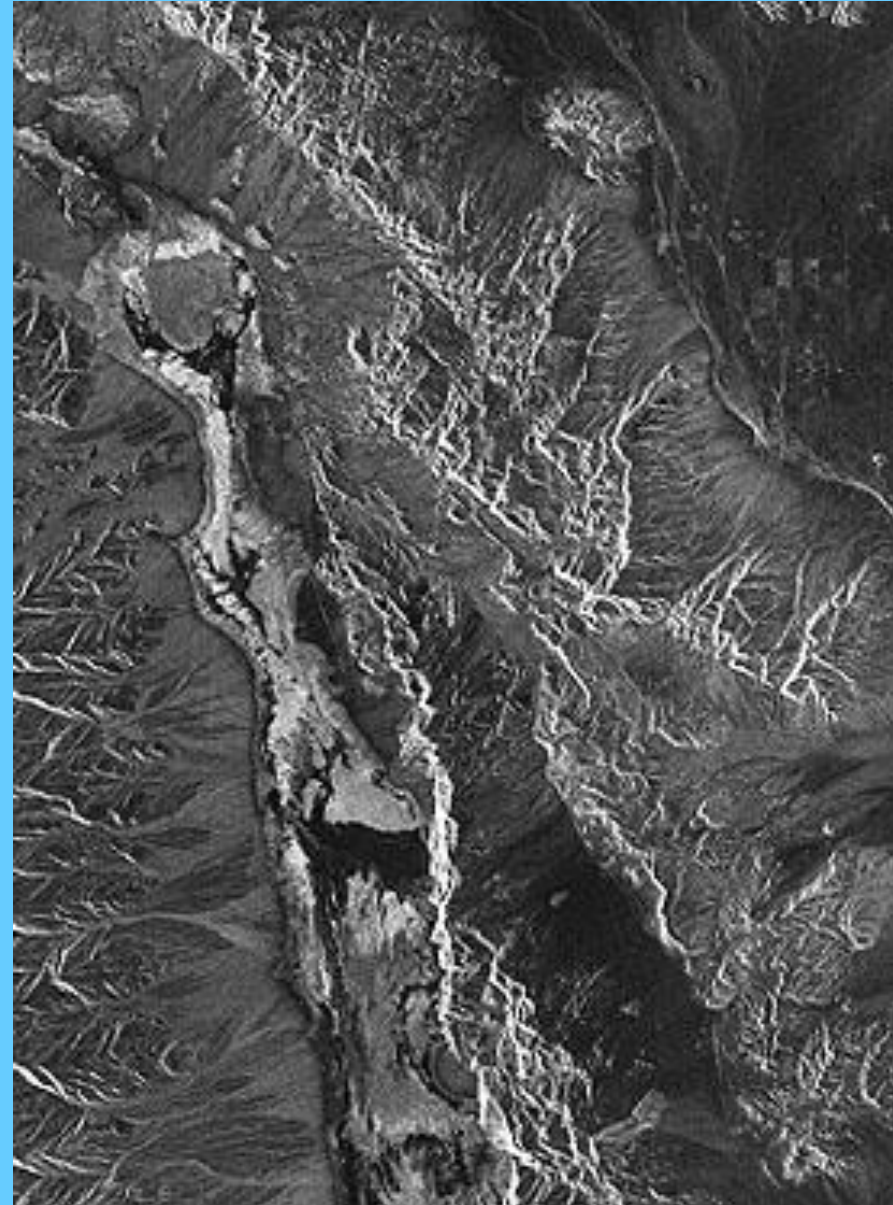



# Radar data

- EGYPT - geology - plutons

left picture: SIR-A radar

right image: Landsat

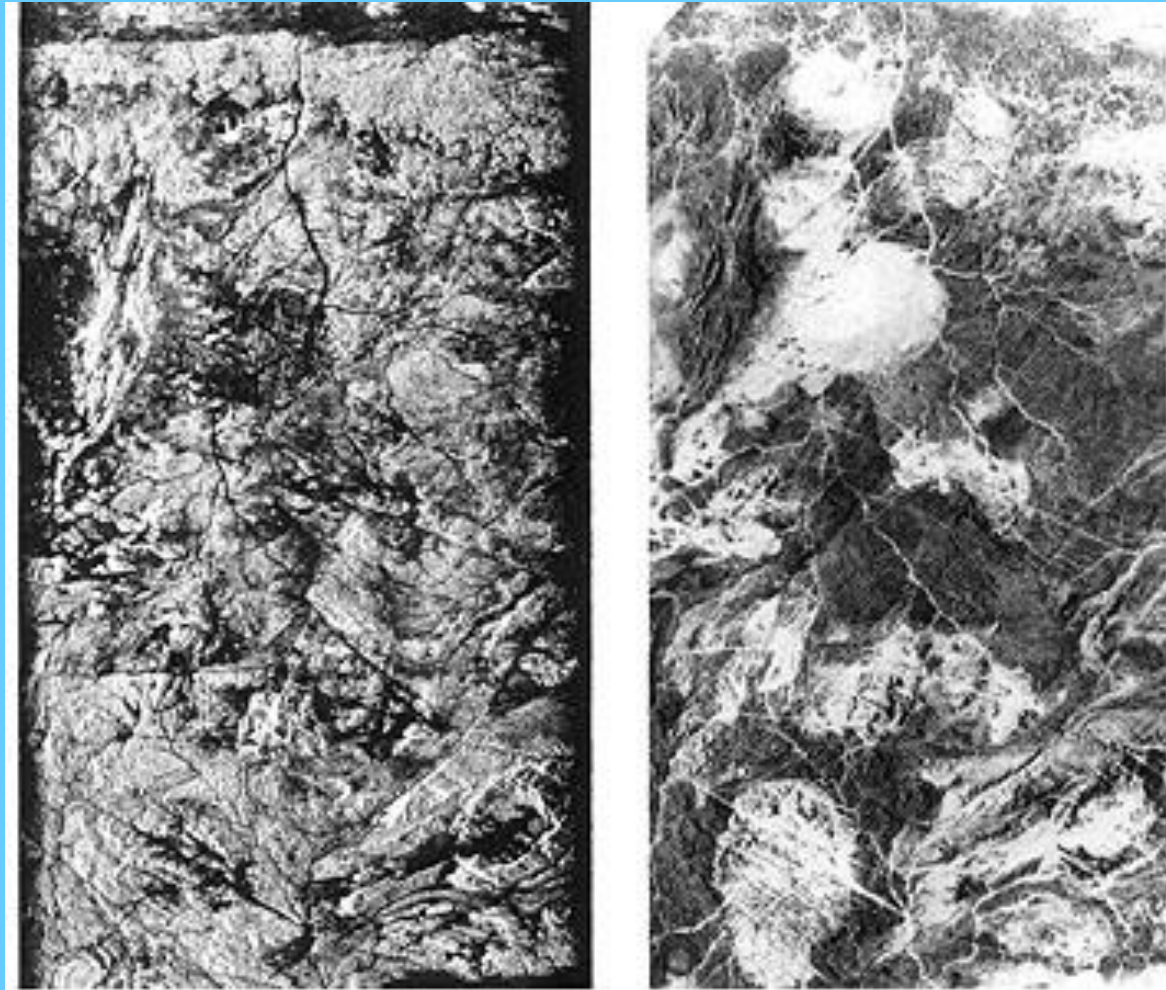

# Radar data



Geologic  
al fault

# Examples of satellite data

Meteosat, channels  
MSG 1, 4, 5

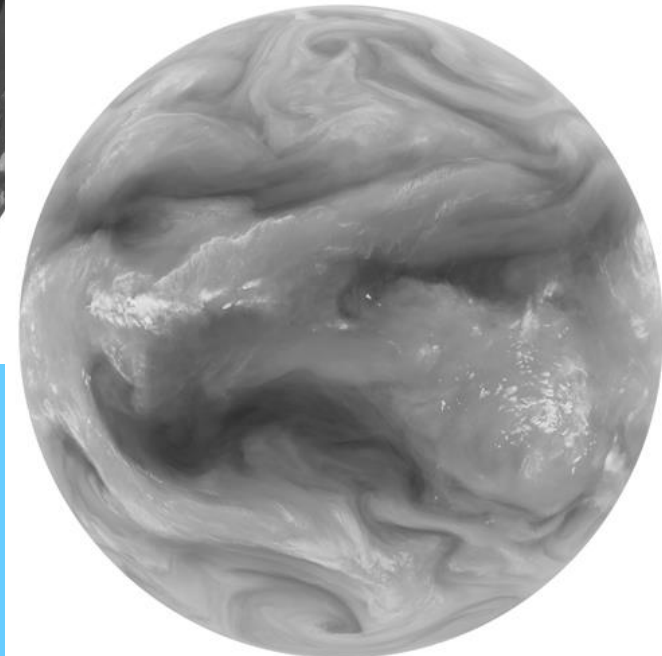
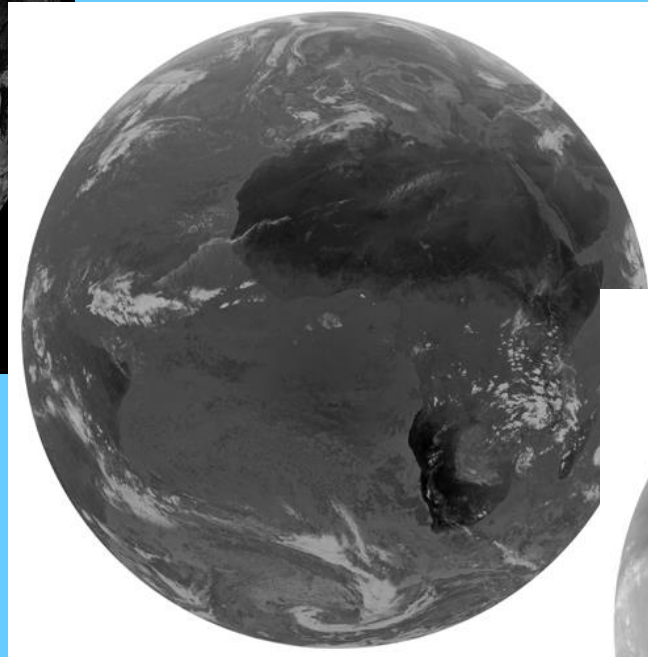
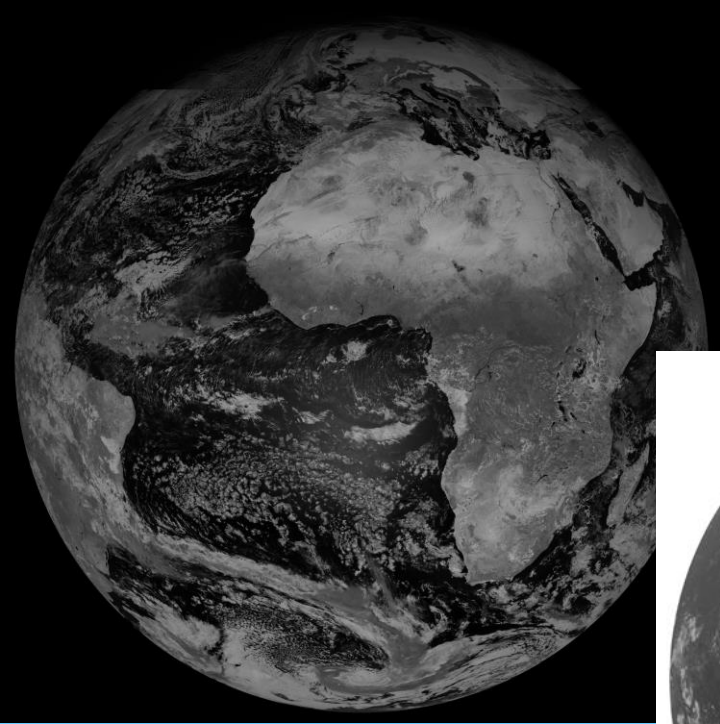



# Examples of satellite data

Rapid Eye, 5m resolution



*Figure 2: Full resolution orthorectified RapidEye image of Irvine corrected without GCPs overlaid with USGS 1:24000 vectors*



# Examples of satellite data

Landsat  
MSS





# Examples of satellite data

Landsat  
TM  
bands 4,5,3

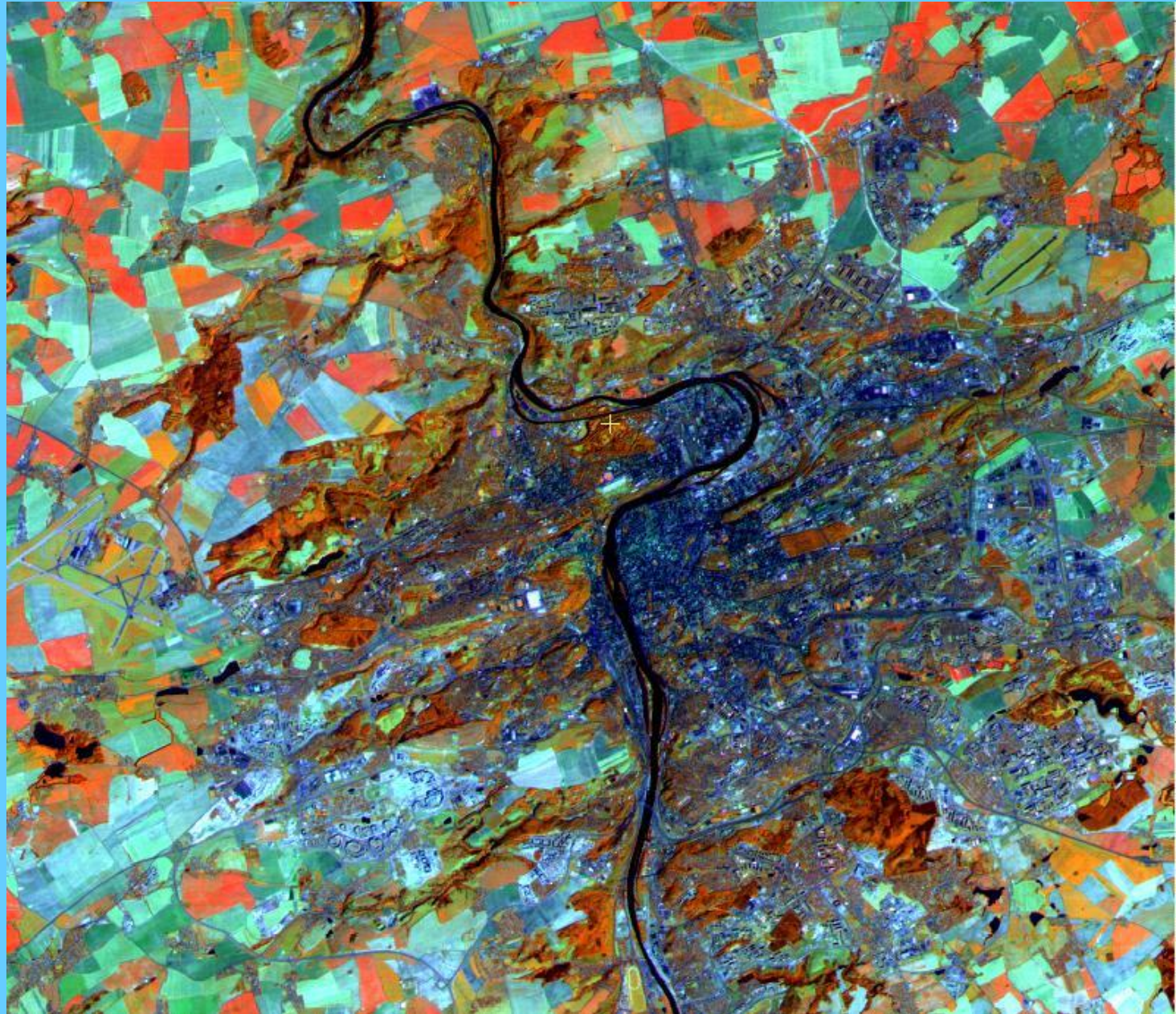



# Examples of satellite data

Peru, Terra/Aster (resolution  
15m)

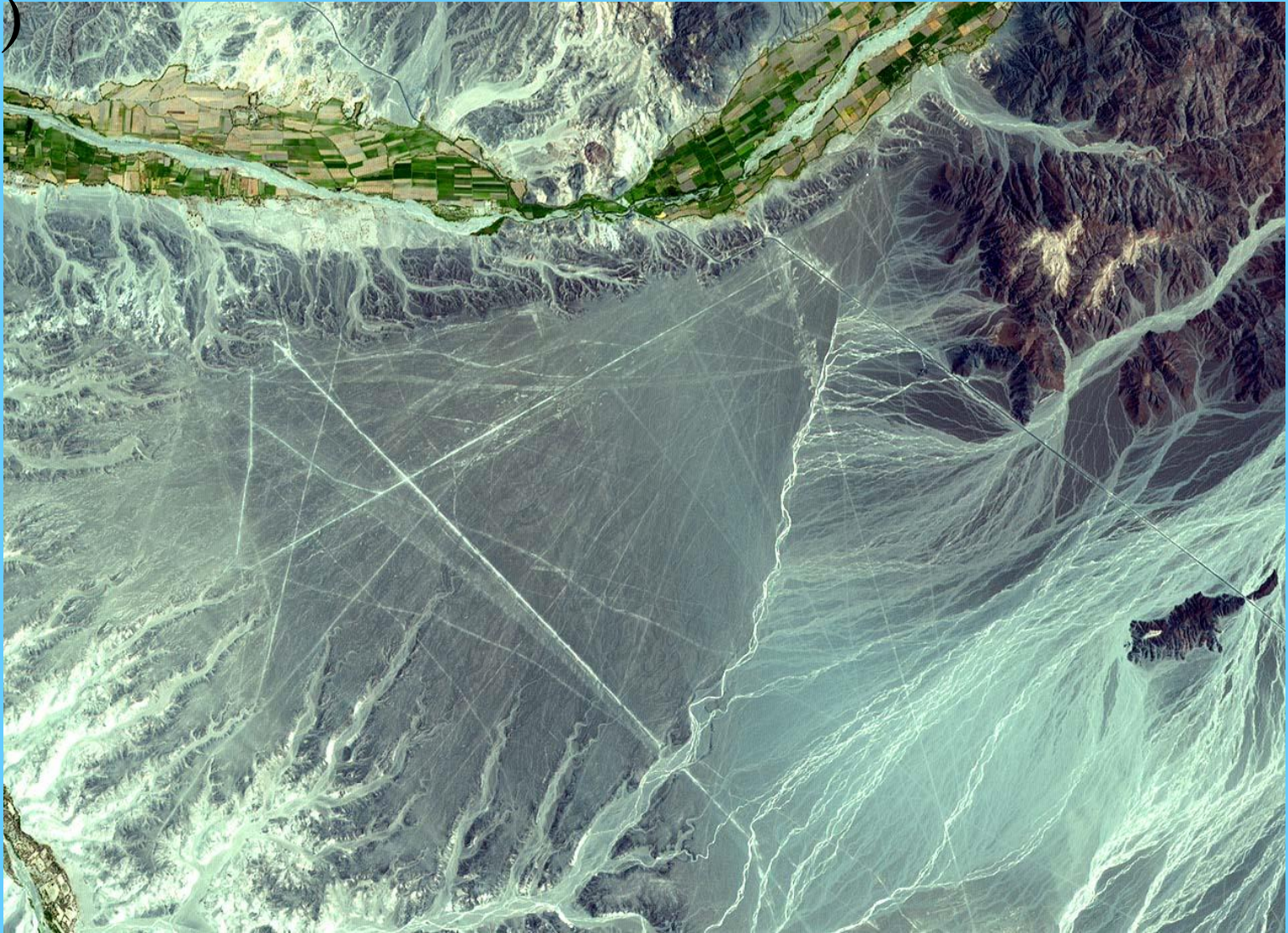



# Examples of satellite data

Peru

QuickBird2,  
(2004,2006)

Resolution

0.65m (2.4m)





# Examples of satellite data

QuickBird,  
panchro  
resolution 0.65m  
(south of Mělník)



# Examples of satellite data

QuickBird, multispectral image, resolution 2.4m, old meanders west of Terežín

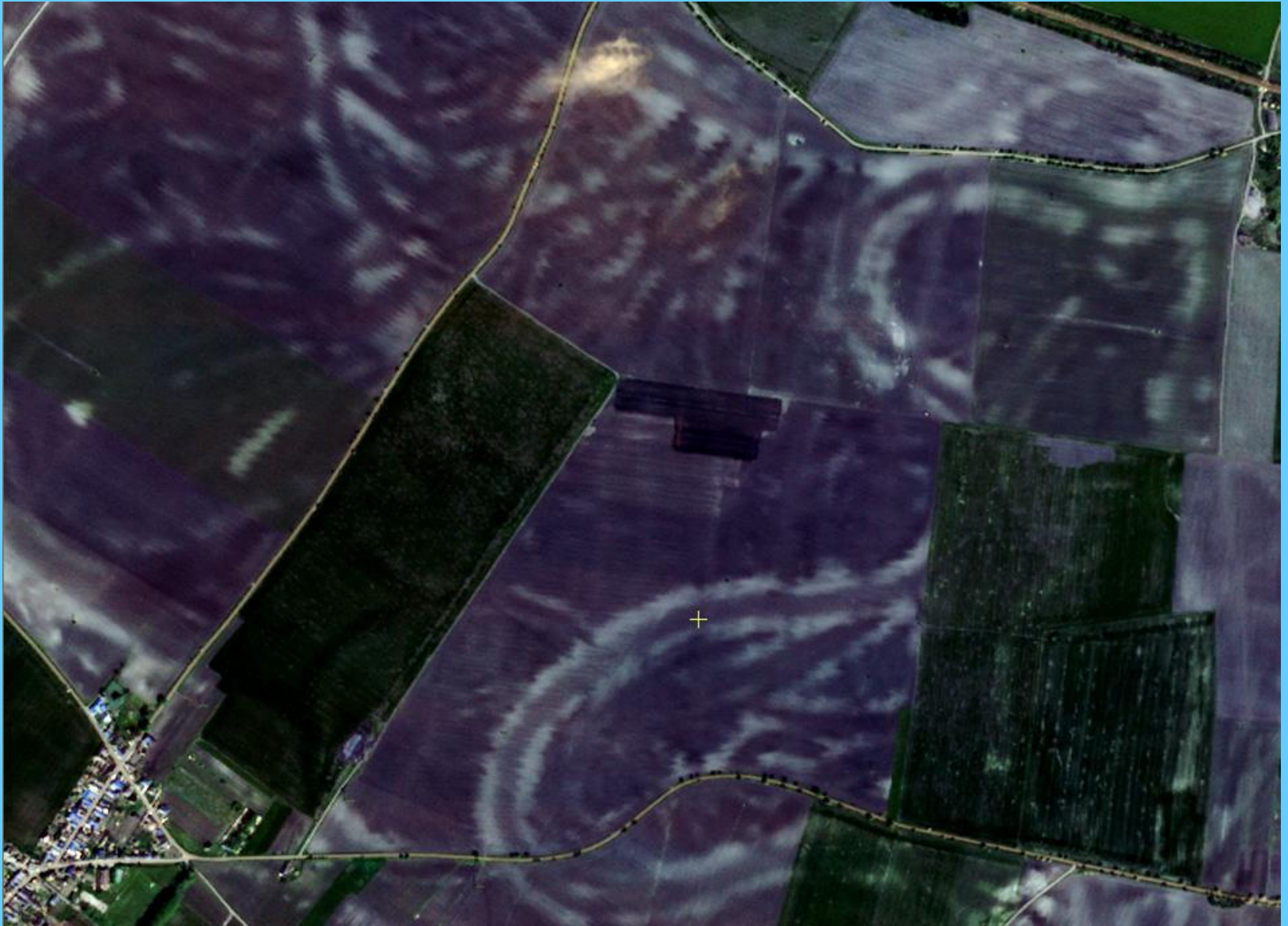



# Examples of satellite data

SPOT, resolution 10m, floods on the Dyje, 2002





# Examples of satellite data



Left- orthophoto, right- image from QuickBird satellite using IR band; visible traces of the archaeological site (earthworks, waste pits, etc.)

# Examples of satellite data

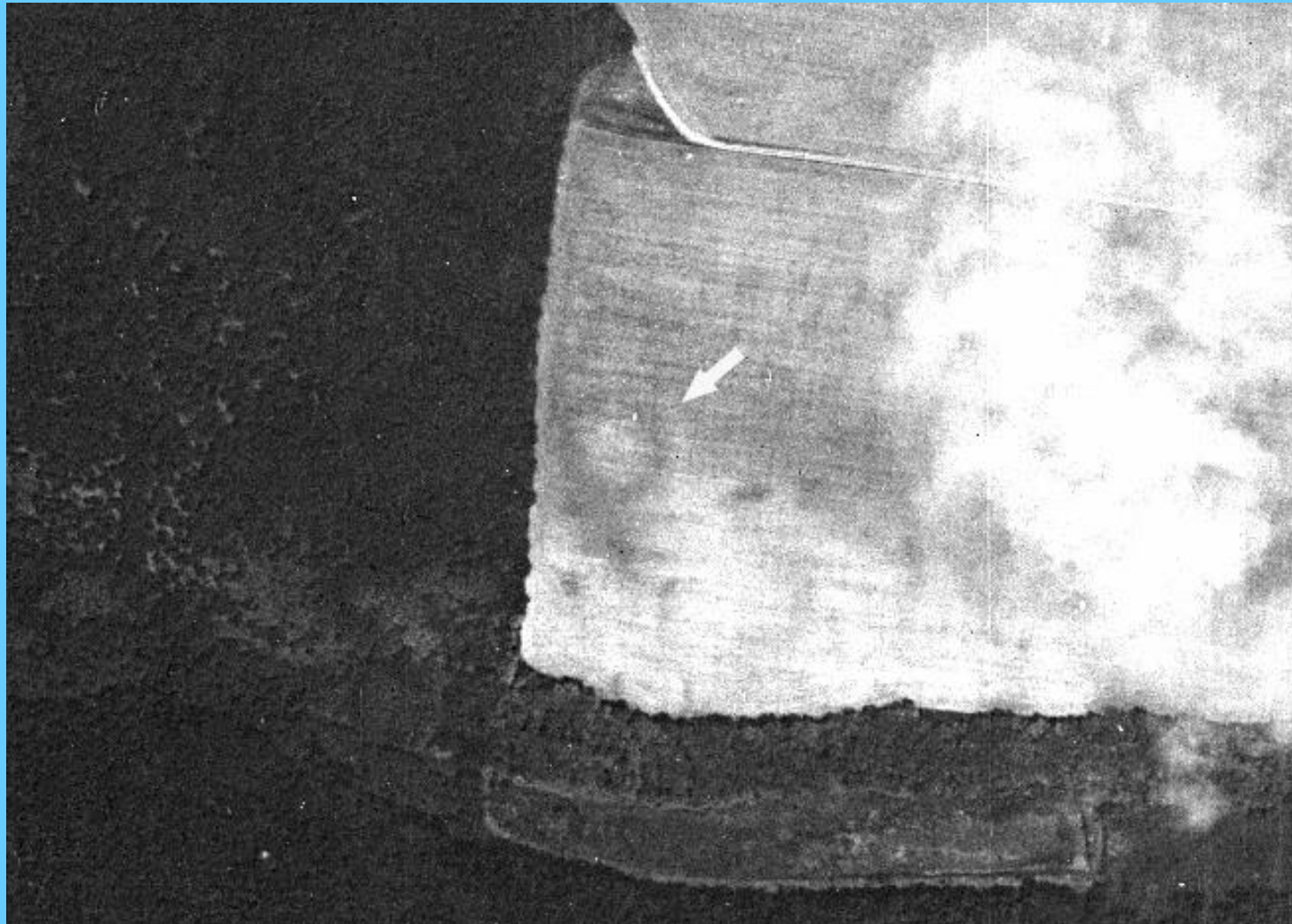

Těšetice , Znojmo KH7-29, 4 June 1966, American spy satellite system Corona; visible palaeolithic roundel



# Examples of satellite data

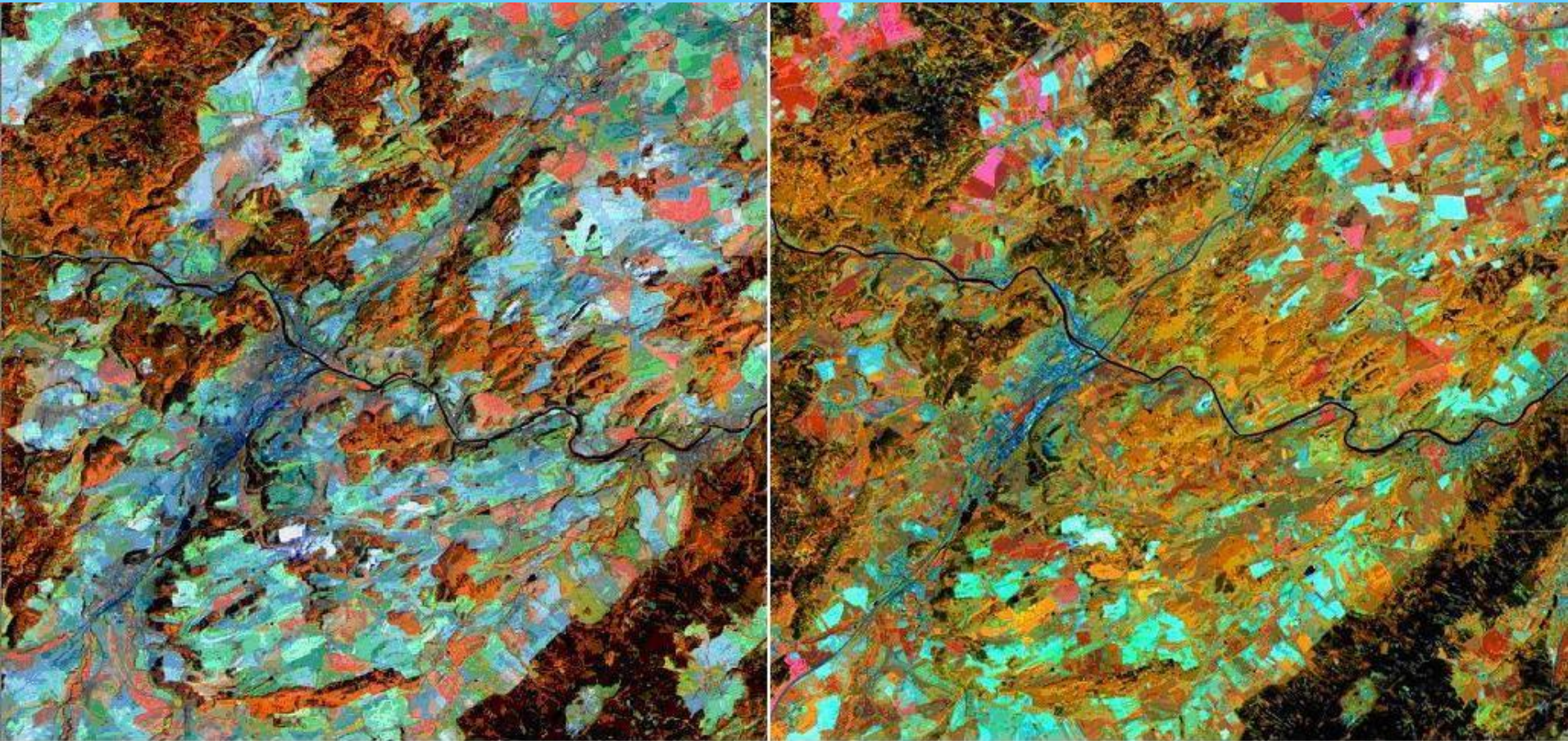

Landsat TM 4,5,3 combination (left, 29.8.1990) and Terra/ Aster 3N,4,2 (right, 28.5.2002), seasonal changes



# Examples of satellite data

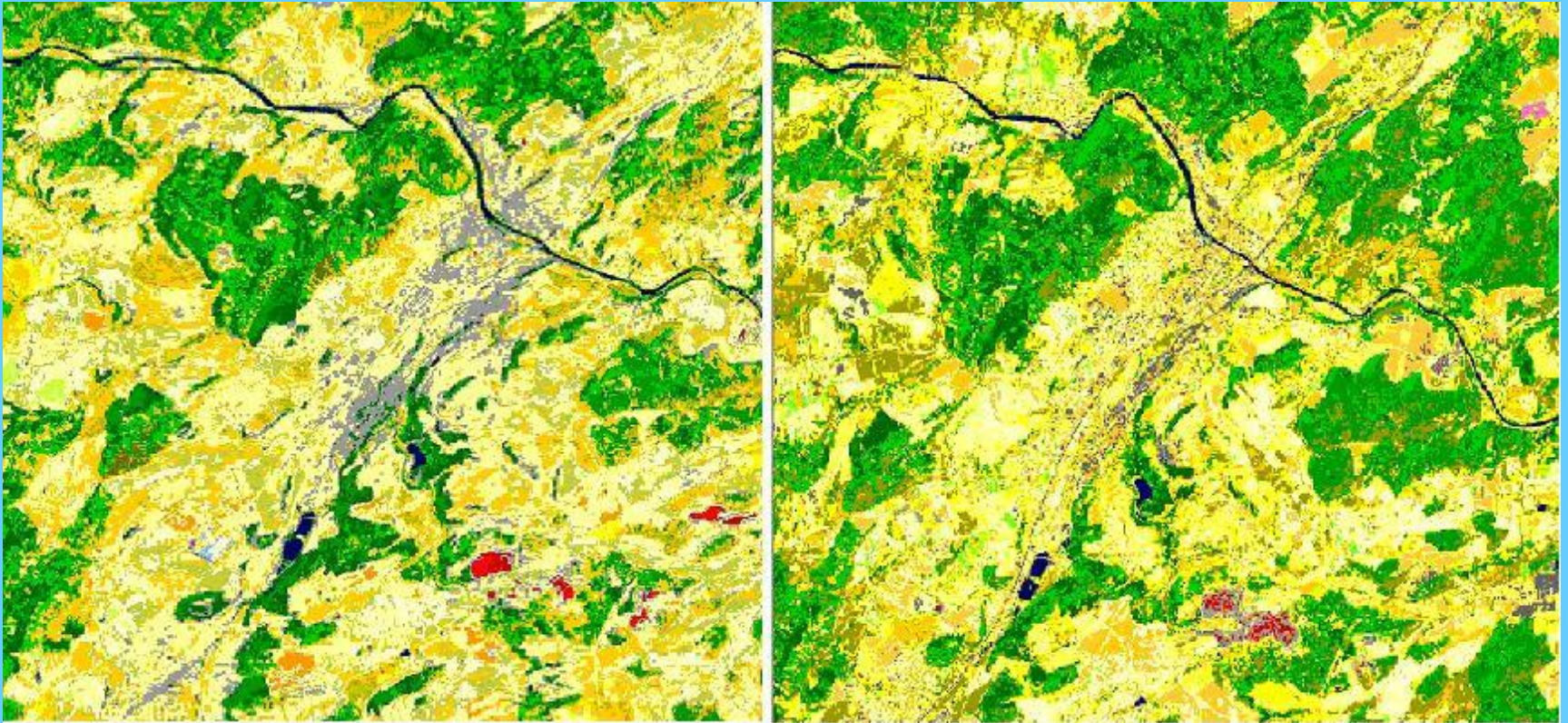

Classification results (isocluss): TM 2,3,4,5,7 (left) and Aster 1,2,3N,4,1/4(5+6+7+8)



# Examples of satellite data

CR- Terra/Aster and the result of processing of digital terrain model and satellite stereoscopic data

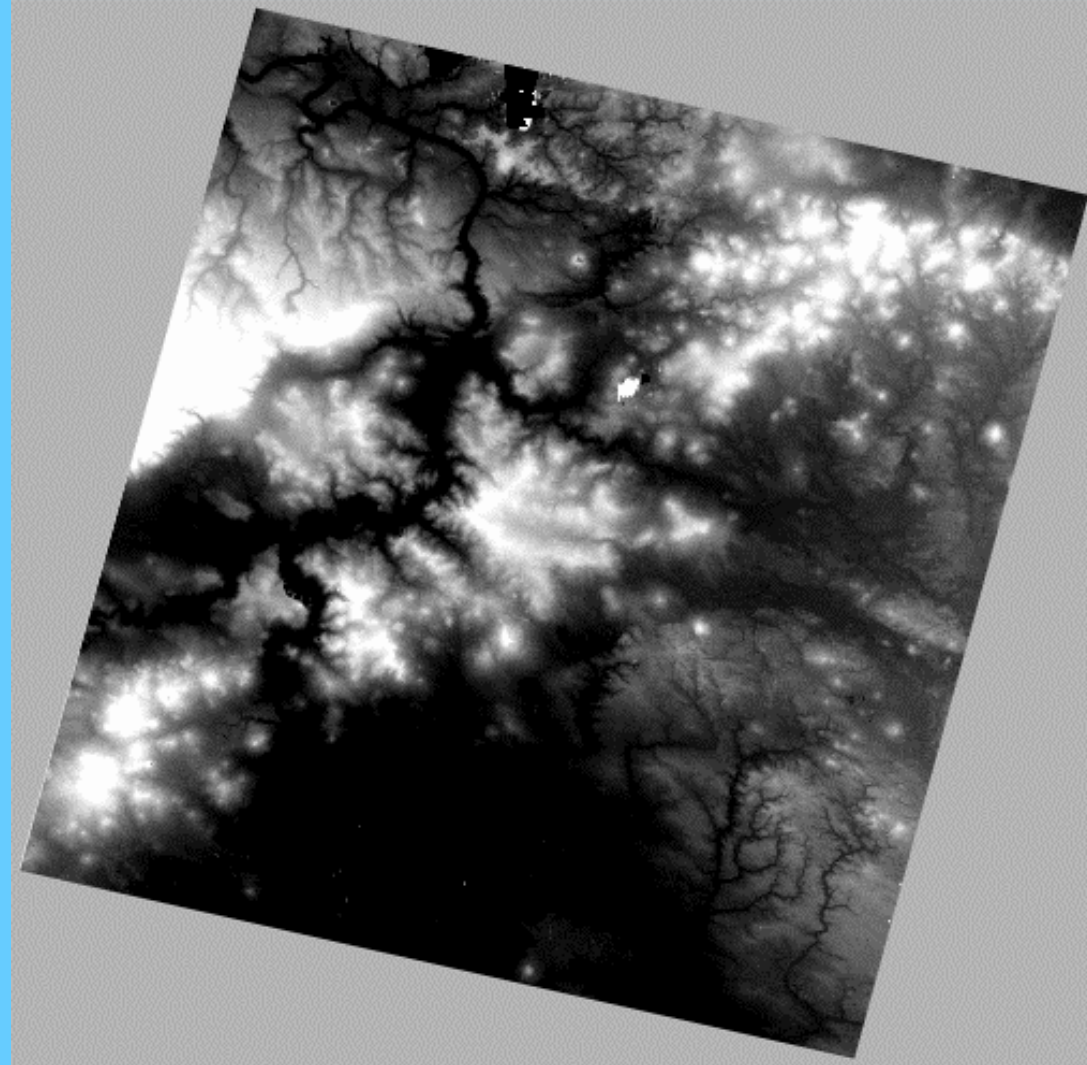
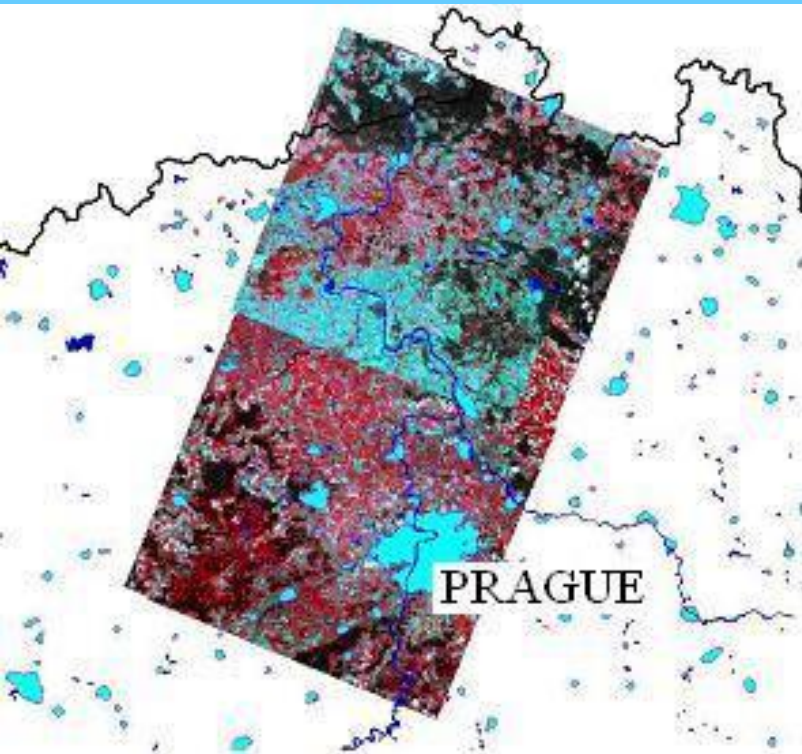



# Examples of satellite data

Iraq/Erbil

Urbanism

QuickBird2,  
(2006)

*pansharpenning*,  
resolution 0.65m



End.

Contact:

Karel Pavelka

pavelka@fsv.cvut.cz